

CO₂ Adsorption on HZSM-5 Zeolite : Mass Transport Study in A Packed Bed Adsorber

Sang Kompiang Wirawan^{1,2*}

Ihda Novia Indrahati¹

Wahyudi Budi Sediawan¹

Panut Mulyono¹

Derek Creaser²

¹Department of Chemical Engineering, Faculty of Engineering, Gadjah Mada University, 55281 Yogyakarta, Indonesia

²Chemical Reaction Engineering, Chalmers University of Technology, SE-412 96 Göteborg, Sweden

Email : skwirawan@chemeng.ugm.ac.id

Experimental and modeling have been done to study and to determine the diffusion parameters of CO₂ adsorption on HZSM-5 zeolite in a packed-bed adsorber. Experiment works consisted of tracer and adsorption experiments. The feed gas concentrations were 40 and 80% CO₂ in helium within various temperatures of 373, 423 and 473 K. The experiments were conducted by using transient step change adsorption. Tracer experiments using 20% Ar/He were conducted to measure dispersion and time lag effect of the packed bed system. A model of CO₂ adsorption on HZSM-5 had been set up for transient packed-bed adsorber by assuming plug flow, isothermal and isobaric, single site Langmuir physisorption, no gas film mass transport resistance and Maxwell-Stefan mass transport in micropore applied. All the data were then optimized to get the best value of modified fitted parameter. The results indicated that at higher temperature, the quantities of gas adsorbed were decrease. This was due to lower adsorption capacity which occurs at higher temperature. The model was in a good agreement with the experiment data. Diffusivity tended to increase by increasing temperatures.

Keywords : transient step-change, surface diffusion, and Maxwell-Stefan

INTRODUCTION

Understanding of gas adsorption in zeolites is of considerable interest due to the wide application of zeolites in industrial

separation and purification processes. Recently, attention has been given to CO₂ adsorption for separation purposes. CO₂ sequestration based on pressure swing adsorption separation has been studied widely for CO₂/CH₄, CO₂/N₂ and other

CO₂ gas mixtures (Calleja *et al.* 1998, Harlick *et al.* 2002, 2003, 2004, Katoh *et al.* 2000). One of the most widely used adsorbents for CO₂ separation is zeolites especially the MFI type, i.e. ZSM-5 and silicalite. Highly crystalline zeolites with a high surface area and a three-dimensional pore structure are expected to be a high-performance adsorbent for CO₂ removal. Positive charged cations are often required in the structure to balance the charge. These cations are exchangeable and influence the adsorption capacity and transport properties of the zeolite. There are many publications concerning CO₂ adsorption over zeolites (Choudhary *et al.* 1996, Dunne *et al.* 1996, Golden and Sircar 1994, Otto *et al.* 1991, Rees *et al.* 1991, Sun *et al.* 1998, Yamazaki *et al.* 1993).

For designing a zeolite gas separation system one needs to consider mass transport through the zeolite (van de Graaf *et al.* 1998). Mass transport through a zeolitic framework is dependent on both the mobility and sorption properties of the diffusing molecules. To study mass transport in the zeolites one should have adsorption and diffusion parameters. These parameters can be provided by experiments and simulations. Previous work had been done by Wirawan and Creaser (2006) to provide the adsorption parameters. The objective of this present work is to provide the diffusion parameters. The operation condition of this work will be the same as the previous work. Single component (CO₂) adsorption is studied by combining experiments with modeling to fit the diffusivity and activation energy. In detail, the objectives of this study are : set up a transient model for single component (CO₂) adsorption on a bed of HZSM-5 zeolite, verify the model with the experimental data to check whether the model agrees with the experimental uptake, and determine the diffusivity of CO₂ in HZSM-5 zeolite as the function of temperature by fitting the diffusion parameters (e.g. diffusivity and activation energy).

Transient step change response experiments in a packed bed adsorber are carried out to determine CO₂ adsorption on HZSM-5 zeolite. This method offers the possibility to determine single component gas adsorption behaviour with a relatively short observation time (Wirawan and Creaser 2006)

MATHEMATICAL MODELING

Packed Bed Adsorber Model Description

Assuming plug flow, the concentration at any position and time can be obtained by solving a set of partial differential equations consisting of mass balances on the sorbent particles in the packed-bed adsorber. The scheme of packed-bed adsorber is illustrated in Figure 1.

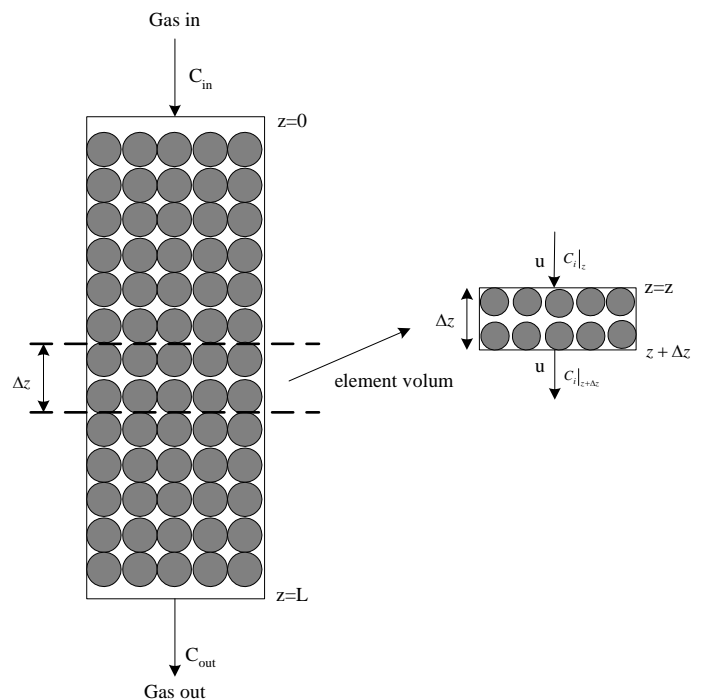

Figure 1. Schematic packed-bed adsorber for mass balance calculation

The proposed model of CO₂ adsorption on HZSM-5 zeolite is based on the following assumption:

1. System is assumed to be isothermal and isobaric.
2. The adsorber is operated with transient uptake.
3. The inert compound does not adsorb and has no direct influence on the mixture isotherm.
4. The concentration in the gaseous phase is calculated from ideal gas law.
5. The geometrical shape of MFI crystals is approximated to be spherical.
6. The adsorption process on HZSM-5 is single site adsorption and follows the Langmuir isotherm.
7. There is no gas film mass transport resistance, so that the concentration on the particle surface is always in equilibrium with the bulk gas concentration.
8. Maxwell-Stefan mass transport in micropores applies.

Assuming gas linear velocity, u at any point along the adsorber is constant and taking into account that the pressure and temperature are constant, we can determine the gas concentrations along the adsorber from a mass balance as :

$$-u \frac{\partial(c_i)}{\partial z} - \left(\frac{1-\varepsilon}{\varepsilon} \right) \rho \frac{\partial \bar{q}_i}{\partial t} = \frac{\partial c_i}{\partial t} \quad (1)$$

where c_i is the molar concentration in the gas phase, u is the fluid phase (absolute) velocity, z is the axial coordinate distance, ε is the bed porosity, ρ is the density of the zeolite crystal and \bar{q} is the average concentration within the spherical crystal with radius r given by:

$$\bar{q}_i = \frac{3}{R} \int_0^R q_i r^2 dr \quad (2)$$

This model follows the model set up by Krishna and Baur (2003). Numerical solution as described by Krishna yields:

$$\frac{\partial c_i}{\partial t} = -u \frac{\partial(c_i)}{\partial z} - \frac{3}{R} \left(\frac{1-\varepsilon}{\varepsilon} \right) N_{iR} \quad (3)$$

The loading along the particle diffusion path is described by another partial differential equation. The geometry of the crystal can be approximated by a sphere, where R is its radius. Assuming that there is no gas film resistance, the concentration at the surface is always in equilibrium with the bulk gas phase. The gas flux as function of surface coverage is :

$$-\frac{1}{r^2} \frac{1}{\rho \cdot q_{i,sat}} \frac{\partial}{\partial r} (r^2 N_i) = \frac{\partial \theta_i}{\partial t} \quad (4)$$

$$\theta_i = \frac{q_i}{q_{i,sat}} \quad (5)$$

where q_{sat} is the saturated molar loading and θ denotes the fractional loading. The fluxes, N_i , are described by the Maxwell-Stefan equations for single component diffusion.

$$N_i = -\rho q_{sat} D \frac{1}{1-\theta_i} \frac{\partial \theta}{\partial r} \quad (6)$$

The boundary condition (BC) is divided into two types, in the particles and in the adsorber.

Boundary conditions in the adsorber :

Initial Condition (IC) :

$$\text{at } t = 0, \quad p_i(z, 0) = 0 \quad (7)$$

Boundary Condition (BC) :

$$\text{at } z = 0, \quad p_i(0, t) = p_{i,in} \quad (8)$$

Boundary conditions in the particle :

Initial Condition (IC) at $t = 0$,

$$\theta_i(r, 0) = 0 \quad (9)$$

Boundary Condition (BC) at

$$r = R; N_1 = f\left(\frac{\partial\theta(R,T)}{\partial r}\right)$$

$$\theta(R, T) = \frac{b_i p_i}{1+b_i p_i} \quad (10)$$

$$r = 0; N_1(0) = 0; \frac{\partial\theta(0,t)}{\partial r} = 0 \quad (11)$$

The equations in the model are categorized as Partial Differential Equation (PDE). To solve the PDEs we use the numerical Method of Lines (MOL). The MOL proceeds in two separate steps: first, spatial derivatives are approximated using, for instance, *finite difference* (FD) or *finite element* (FE) techniques. Second, the resulting system of semi-discrete ordinary differential equations (ODE) in the initial value are integrated with respect to the independent variable (Cutlip and Shacham 2000).

Temperature Dependence on Diffusivity

As the molecules are continuously moving in the force field of the zeolite channels, the diffusion process can be described as an activated process. The temperature dependence of surface diffusion is both expressed in the adsorption constant, b , and the diffusivity, D_i . The adsorption equilibrium constant b can be expressed in term of enthalpy and entropy of adsorption as expressed in Equation (12).

$$b_i = \exp\left(\frac{-\Delta H_i}{R_g T} + \frac{\Delta S_i}{R_g}\right) \quad (12)$$

where ΔS_i is the entropy, ΔH_i is the heat of adsorption of species i , R_g is the gas constant and T is the temperature. The adsorption parameters including ΔH , ΔS and q_{sat} were obtained from the previous research conducted by Wirawan and Creaser (2006) as shown in Table 1.

Table 1. Parameter of CO₂ adsorption on HZSM-5 zeolite

Parameters	Values
q_{sat} (mmol.g ⁻¹)	2.14 ± 0.008
$-\Delta H$ (kJ.mol ⁻¹)	28.7 ± 0.1
$-\Delta S$ (J.mol ⁻¹ .K ⁻¹)	82.7 ± 0.2

(Wirawan and Creaser 2006)

Temperature dependence on diffusivity can accordingly be described by an Arrhenius-type equation:

$$D(T) = D_0 \exp\left[-\frac{E_{D,i}}{RT}\right] \quad (13)$$

with D_0 is the pre-exponential term of diffusivity, and $E_{D,i}$ is the activation energy of diffusion of species i . This dependency is usually explained by assuming that diffusion takes place via a sequence of activated hops. The pre-exponential term (D_0) is related to the elementary rate at which particles attempt to hop to a neighboring adsorption site, while the exponential expresses the chance that the particles are able to overcome the free energy barrier $E_{D,i}$ between the sites.

EXPERIMENTAL METHOD

The powdered HZSM-5 samples used in the experiments were supplied by Eka Chemicals, Sweden. The physical properties of HZSM-5 powders are listed in Table 2. A vertical quartz glass tube reactor (diameter 25 mm) was used, with a downward gas flow to avoid particle fluidization. The powdered sample of 1.75 g was supported on a quartz frit to distribute the gas evenly over the reactor cross-section. The reactor was heated in a cylindrical oven and the temperature was controlled by a thermocouple mounted directly downstream from the sample bed. Separate mass flow controllers (Bronskhorst Hi-Tec) were used to mix the reactor feed stream

from Ar, CO₂ and He (AGA gas, Sweden, purities greater than 99.999%). Helium was used as the inert and sweep gas in all experiments. The mass flow controllers were arranged in two sets, connected through a 4-way valve (Valco Instruments model VICI 90 A) to the reactor, to enable switches of the reactor feed between sweep gas (He) and the He/sorbate gas mixture. Outlet gas concentrations from the reactor were detected by a quadrupole mass spectrometer (Fison Gaslab 300). Prior to each adsorption experiment, the sample was degassed at 723 K for 4 hours in He. The sample was cooled to the desired adsorption temperature in He. The scheme of the experimental apparatus for adsorption measurements is depicted in Figure 2.

Table 2. Physical properties of HZSM-5 zeolite

Properties	Values
Si/Al molar ratio	27
BET surface area	422 m ² g ⁻¹
Solid density	1800 kg.m ⁻³
Average particle size	12 μm

(Eka Chemicals, Sweden)

A transient step change adsorption experiment consisted of tracer and CO₂ adsorption experiment. The tracer experiment was performed with a gas mixture of 20% Argon in Helium. The adsorption experiments used He/CO₂ gas mixtures with CO₂ concentrations of 40% and 80%. The CO₂ adsorption experiments were conducted at 273, 425 and 473 K and a total pressure of 1 atm under all conditions. Helium, for both tracer and adsorption experiments, was the inert gas. The total gas flow rate was 50 mL/min (ambient conditions) for all experiments. The dispersion and time lag of the reactor system was determined from tracer experiments with 20% Ar/He over the sample. Ar was used as the tracer gas, since it has been reported to have a negligible uptake compared to CO₂. The uptake of each component was calculated by

integrating the difference between the normalized time response curves of the tracer experiment and the sorbent experiment as detailed in reference (Wirawan and Creaser 2006).

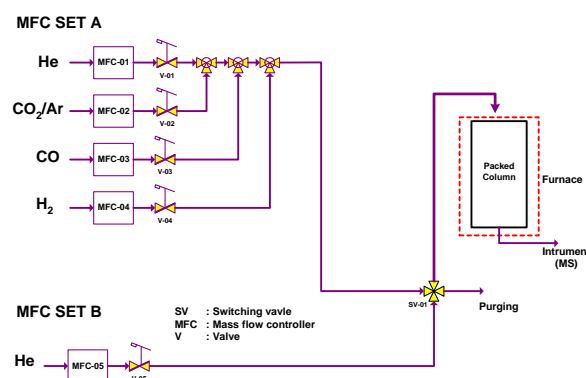

Figure 2. Scheme of adsorption equipment setup

RESULTS AND DISCUSSION

Tracer and Adsorption Experiment

Tracer experiments were conducted to characterize the packed-bed system, involving measurements of dispersion and time lag effects in the adsorbent and reactor system. It is seen that there is a distribution of time that molecules spend in the system in contact with the bed particles (Fogler, 1990). The residence time distribution (RTD) analysis consists of calculations of mean residence time (t_m), variance (σ), number of tank in series (n), dispersion number (D_a) and Peclet number (Pe). Tracer experiments used a mixture of Ar/He gases with the concentration of Ar 20% and the CO₂ adsorptions were conducted by using a mixture of CO₂/He gases with inlet gas concentrations of 40 and 80% (volume) at 373 K, 423 K and 473 K. The adsorption parameters used to measure the quantities of gas adsorbed were obtained from previous work conducted by Wirawan, 2006. The typical breakthrough curve

for tracer Ar/He and CO₂ adsorption is depicted in Figure 3.

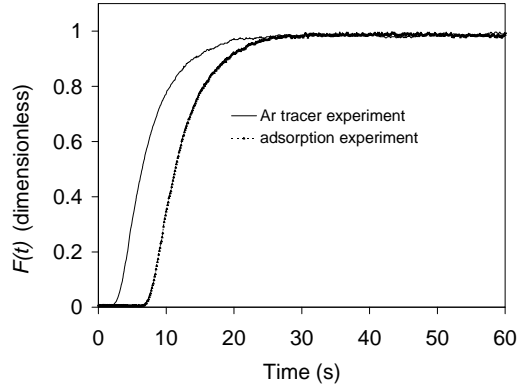

Figure 3. Typical Breakthrough Curve (F(t) vs. time) for tracer and adsorption experiments

The mean residence time (t_m) was calculated by using Equation (14) (Fogler 1990)

$$t_m = t_s - \int_{t=0}^{t=t_s} F(t) dt \quad (14)$$

where t_m is the mean residence time, t_s is the saturation time and $F(t)$ is the fraction of effluent which has been in the system for less than time t and called the cumulative distribution function. The saturation time (t_s) is reached when the outlet concentration was equal to the inlet concentration ($y = y_0$) or the ratio between outlet and inlet concentrations (y/y_0) was equal to 1. The variance (σ), numbers of tank in series (n), dispersion number (D_a) and Peclet number (Pe) can be calculated using the following equations,

$$\sigma^2 = (t_s - t_m)^2 - 2 \int_{t=0}^{t=t_s} (t - t_m) F(t) dt \quad (15)$$

$$n = \frac{t_m^2}{\sigma^2} \quad (16)$$

$$\frac{\sigma^2}{t_m^2} = \frac{2}{Pe} - \frac{2}{Pe^2} [1 - \exp(-Pe)] \quad (17)$$

From the tracer experiment, it was obtained the mean residence time was 8.75 s. The variance (σ^2) was 16.24 s². By using mean residence time and variance then the numbers of tank in series (n) could be determined. From this calculation n was equal to 5. This means that the gas flow the packed-bed system could be represented by 5 tanks in series. The corresponding dispersion number (D_a) and Peclet number (Pe) were 6.65 cm².s⁻¹ and 8.29 respectively. The porosity of the bed (ϵ) was determined by varying the model value of ϵ (with no adsorption) until the breakthrough curve of the model agreed well with the breakthrough curve of the experimental data. From the optimization, the value of the porosity, ϵ , was 0.3.

Verification of the Model with Experimental Data

The model was fitted with the experimental data for verification purposes. The objective was to see whether the proposed model could represent the experimental data. From Figure 4, 5 and 6 it can be seen that the model was agrees adequately with the experimental data for both inlet CO₂ concentrations at various temperatures.

The modified fitted parameters were of D_m and E_{Dm} . The mean temperature (T_m) chosen for this fitting was 423 K. All the model predictions (six experiments) were optimized together to get the best value of the fitted parameters by minimizing the sum of square errors (SSE) and continued by confidence interval calculation (Draper and Smith 1998). Equation (18) was applied in order to reduce the correlation between the optimized parameters, because here two parameters were optimized together (D_m and E_{Dm}).

$$D(T) = D_m \exp \left[-\frac{E_{Dm}}{R_g T} - \frac{E_{Dm}}{R_g T_m} \right] \quad (18)$$

The optimization yielded the value of $D_m = (1.5519 \pm 0.0031) \times 10^{-8} \text{ m}^2 \cdot \text{s}^{-1}$ and the value of $E_{Dm} = 5.0907 \pm 0.0024 \text{ kJ} \cdot \text{mol}^{-1}$, then the diffusivity of CO₂ on HZSM-5 for various temperatures could be derived as:

$$D(T) = 1.5519 \times 10^{-8} \exp \left[-\frac{5090.7}{R_g T} - \frac{5090.7}{R_g T_m} \right] \quad (19)$$

The values obtained from optimization were acceptable by considering the confidence level.

The diffusivity for each temperature (373, 423 and 473 K) calculated using Equation (19) was 7.0678×10^{-10} , 8.5814×10^{-10} and $10.000 \times 10^{-10} \text{ m}^2 \cdot \text{s}^{-1}$. It is seen here that diffusivity increased with increasing temperature.

Molecular transport in the zeolitic framework depends on the mobility and sorption of the diffusing molecule. On the zeolite surface, transport of molecules takes place via a sequence of jumps from one adsorption site to another. Surface diffusion thus occurs by an activated process. Diffusivity is coupled to adsorption. For single component diffusion, where interaction only occurs between the diffusing molecules and the zeolite, the diffusivity is then only a function of the occupancy (surface concentration). The occupancies depend on adsorption, so if temperature increases, occupancy is lower and that lowers the diffusivity. However, at the same time the diffusivity increases because it also has a direct dependence on the temperature, as expressed in Equation (19), via the activation energy. Parameter fitting resulted in $E_{Dm} = 5.0907 \text{ kJ} \cdot \text{mol}^{-1}$, it means that a molecule needs at least 5.0907 kJ to jump from one site to the adjacent sites. E_{Dm} represents energy barrier that a molecule must overcome

when moving through the zeolite channels. Heat of adsorption, ΔH , for this present work is $28.7 \pm 0.1 \text{ kJ} \cdot \text{mol}^{-1}$, while estimated value of activation energy E_{Dm} is $5.0907 \pm 0.0024 \text{ kJ} \cdot \text{mol}^{-1}$. It is seen that heat of adsorption of CO₂ is much greater than activation energy for diffusivity. It seem reasonable that it should require more energy for a CO₂ molecule to completely leave the zeolite surface and go into the gas phase rather than transfer from one adsorption site to another. For this case, adsorption has a greater influence on the diffusivity.

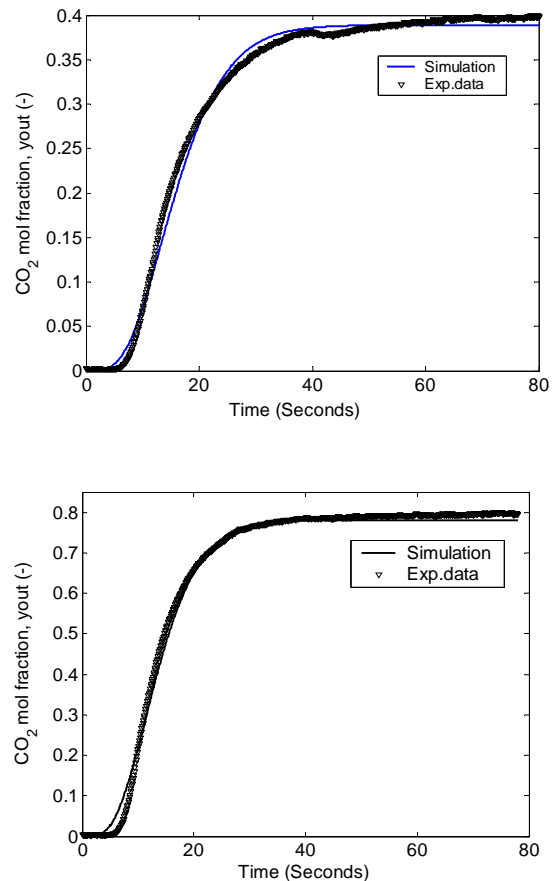

Figure 4. Experimental data and fitted model at 373 K for inlet gas concentration 40% (above) and 80 % (below)

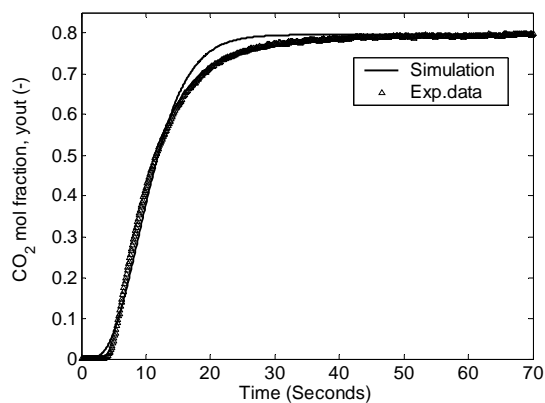
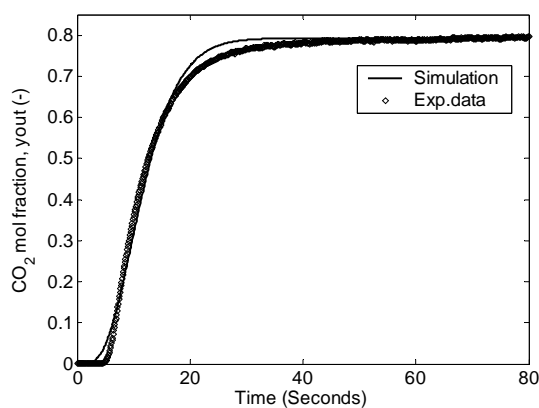
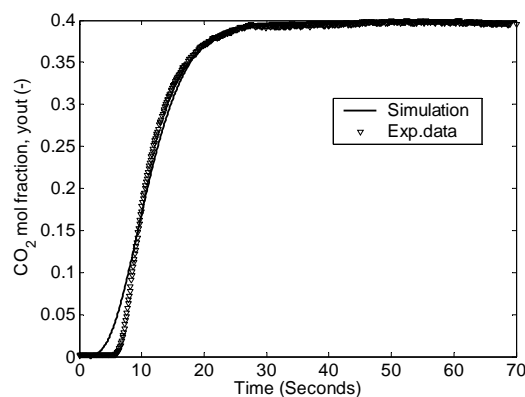
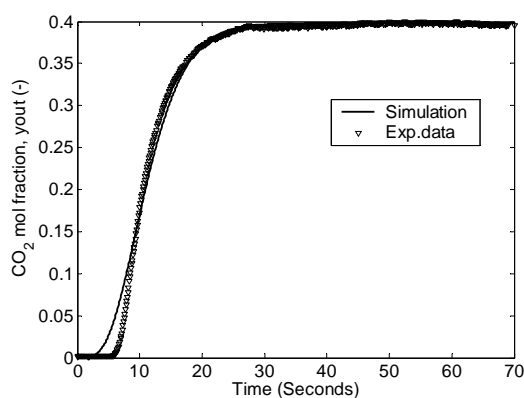

Figure 5. Experimental data and fitted model at 423 K for inlet gas concentration 40% (above) and 80 % (below)

Figure 6. Experimental data and fitted model at 473 K for inlet gas concentration 40% (above) and 80 % (below)

Silicalite-1 has the same channel framework (MFI type) as HZSM-5 but free alumina. In comparison with Silicalite-1, Kärger *et al.* (1993) reported the pre-exponential factor (D_0) and activation energy (E_D) of intracrystalline self-diffusion of CO_2 are $(1.7 \pm 0.7) \times 10^{-8} \text{ m}^2 \cdot \text{s}^{-1}$ and $4.5 \pm 1 \text{ kJ} \cdot \text{mol}^{-1}$. These values give the diffusivity of CO_2 in silicalite-1 is one order of magnitude greater than in HZSM-5 at same temperature. The presence of alumina makes HZSM-5 becomes acidic. Protons (H^+) in HZSM-5 act as a Brønsted acid site. CO_2 has a permanent electrostatic moment in the form of quadrupole moment ($Q/e = -4.3 \times 10^{-30} \text{ m}^2$). Probably, acidic sites of HZSM-5 interact with

the quadrupole moment of CO_2 . Thus, because of this interaction, the presence of the acidic sites increases the residence time for the molecules at the adsorption site via stronger interaction (Koriabkina 2005). In the cation-free zeolite framework of Silicalite-1, the electrostatic moments of the adsorbed molecules should be minor influence (Kärger, 1993).

Model Sensitivity

Model sensitivity was tested by simulation of the crystal diameter. This simulation was used to see the effect of increasing or decreasing the crystal

diameter (from the estimated value) on the fitted diffusivity. This comparison is important because the exact average crystal size (diameter) is unknown, only a range of crystal diameter of the sample was known. Perhaps, even a difference of only a fraction of an angstrom can change the diffusivity by orders of magnitude. This present work used crystals with diameters ranging from 9 to 25 μm . An average diameter of 12 μm , was used for the modeling work.

The simulations were conducted for diameters of 6, 10, 12, 16, 20, 24, 80 and 100 μm . The results of the simulations of adsorption uptake with an inlet concentration 40% at 373 to 473 K are depicted in Figure 7.

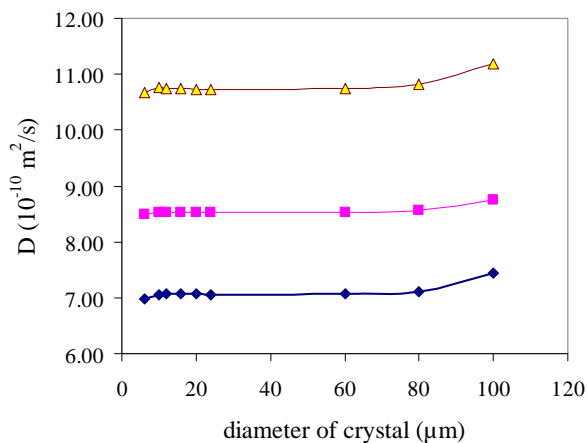

Figure 7. Effect of crystal diameter on diffusivity for adsorption uptake with inlet concentration 40% (simulation result)

Figure 7 indicates that in the diameter range of 10 μm up to 60 μm , the diffusivity changed little with increasing temperature. But in the range from 60 – 80 μm the diffusivity tended to increase and when diameter of the crystal approached 100 μm , the diffusivity increases significantly but still within the same order of magnitude. Since the diffusivity did not change so much in the range 10 – 25 μm , it can be considered safe to work at with chosen diameter

(12 μm) or any size within the range, with little effect on the fitted diffusivity.

CONCLUSIONS

Experiments and modeling have been done to study and to determine the diffusion parameters for a case study of CO₂ adsorption in a packed-bed adsorber. Step change experiment and modeling were set

up for CO₂ adsorption in a packed-bed adsorber for inlet gas concentration of 40% and 80% at $T=373, 423$ and 473 K. The results revealed that the proposed model achieved good agreement with the experimental data. The model assumes that surface diffusion is the mode of transport of CO₂ into the material. The zeolite crystals are assumed to be spherical with an average crystal size. Convective transport in the bed was represented as flow through a series of tank reactors in order to reproduce the dispersion and time lag measured by tracer experiments. The diffusivity of CO₂ on HZSM-5 as a function of temperature can be expressed as:

$$D(T) = 1.5519 \times 10^{-8} \exp \left[-\frac{5090.7}{R_g T} - \frac{5090.7}{R_g T_m} \right]$$

where T_m is the mean temperature of the experiment ($T=423$ K). This expression is valid over a temperature range of 373 to 473 K with average error of 2.25 %.

NOMENCLATURE

b	Langmuir adsorption isotherm constant (Pa^{-1})
c_i	molar concentration of species i ($\text{mol} \cdot \text{m}^{-3}$)
D	diffusivity ($\text{m}^2 \cdot \text{s}^{-1}$)
D_0	pre-exponential factor for diffusivity ($\text{m}^2 \cdot \text{s}^{-1}$)

D_m	pre-exponential factor for modified diffusivity (m^2s^{-1})	ZSM-5 Zeolites with Different SiAl Ratios," <i>J. Chem. Eng. Data</i> , 43, 994.
E_D	activation energy for diffusivity ($kJ.mol^{-1}$)	Choudhary, VR., Mayadevi, R., Rao, M., Sircar, S., Gorte, R.J., Myers, A.L. (1996). "Calorimetric Heats of Adsorption and Adsorption Isotherms. 1. O ₂ , N ₂ , Ar, CO ₂ , CH ₄ , C ₂ H ₆ , and SF ₆ on Silicalite," <i>Langmuir</i> , 12, 5888.
E_{Dm}	activation energy for modified diffusivity ($kJ.mol^{-1}$)	Cutlip, M. B. and Shacham, M.,(2000). <i>Problem Solving in Chemical Engineering with Numerical Methods</i> , Prentice-Hall, Inc., New Jersey, pp.112-114.
$F(t)$	cumulative distribution function	Dunne, J.A., Mariwala, R, Rao, M., Sircar, S., Gorte, R.J., Myers, A.L. (1996). "Calorimetric Heats of Adsorption and Adsorption Isotherms. 1. O ₂ , N ₂ , Ar, CO ₂ , CH ₄ , C ₂ H ₆ , and SF ₆ on Silicalite," <i>Langmuir</i> , 12, 5888.
N	molar flux ($mol.m^{-2}.s^{-1}$)	Fogler, H. S., (1999), <i>Element of Chemical Reaction Engineering</i> , 3 rd ed., Prentice- Hall, Inc., New Jersey, 809-887
n	number of tanks representing the bed	Golden, T.C., Sircar, S. (1994). "Gas Adsorption on Silicalite," <i>J. Colloid Interface Sci.</i> , 162, 182.
p	partial pressure (Pa)	Harlick, P.J.E., Tezel, F.H. (2002). "Adsorption of Carbon Dioxide, Methane and Nitrogen: Pure and Binary Mixture Adsorption by ZSM-5 with SiO ₂ /Al ₂ O ₃ Ratio of 30," <i>Sep. Sci. Technol.</i> , 37, 33.
Pe	Peclet number	Harlick, P.J.E., Tezel, F.H. (2003). "Adsorption of carbon dioxide, methane and nitrogen: pure and binary mixture adsorption for ZSM-5 with SiO ₂ /Al ₂ O ₃ ratio of 280," <i>Sep. Purif. Technol.</i> , 33, 199.
q	molar loading ($mol.kg^{-1}$)	Harlick, P.J.E., Tezel, F.H. (2004). "An experimental adsorbent screening study for CO ₂ removal from N ₂ ," <i>Microporous Mesoporous Mater.</i> , 76, 71.
q_{sat}	saturation loading ($mol.kg^{-1}$)	Katoh, M., Yoshikawa, T., Tomonari, T., Katayama, K., Tomida, T. (2000). "Adsorption Characteristics of Ion-Exchanged ZSM-5 Zeolites for CO ₂ /N ₂ Mixtures," <i>J. Colloid Interface Sci.</i> , 226, 145.
\bar{q}	average loading ($mol.kg^{-1}$)	Koriabkina, A. O., de Jong, A. M., Hensen, E. J. M. and van Santen, R. A.(2005). Concentration and Temperature Dependence of The Diffusivity of n-Hexane in MFI Zeolites,
R_g	gas constant ($J.mol^{-1}.K^{-1}$)	
R	radius of particle (m)	
r	radial distance coordinate (m)	
T	temperature (K)	
T_m	mean temperature (K)	
t	time (s)	
t_m	mean residence time (s)	
t_s	saturation time (s)	
u	absolute velocity (ms^{-1})	
y	gas phase fraction (-)	
z	axial coordinate (m)	
ε	bed porosity (-)	
ρ	density of the zeolite crystal ($kg.m^{-3}$)	
θ	fractional loading (-)	
σ^2	variance (s^2)	

ACKNOWLEDGEMENTS

The authors are grateful for the financial support of the Swedish Energy Agency and the SIDA-Swedish Research Links program for support. Dr. Olov Öhrman of the Chemical Technology Division of Luleå University of Technology, Sweden is thanked for supplying the HZSM-5 sample.

REFERENCES

Calleja, G., Pau, J., Calles, J.A. (1998). "Pure and Multicomponent Adsorption Equilibrium of Carbon Dioxide, Ethylene and Propane on

- ZSM-5 Zeolites with Different SiAl Ratios," *J. Chem. Eng. Data*, 43, 994.
- Choudhary, VR., Mayadevi, R., Rao, M., Sircar, S., Gorte, R.J., Myers, A.L. (1996). "Calorimetric Heats of Adsorption and Adsorption Isotherms. 1. O₂, N₂, Ar, CO₂, CH₄, C₂H₆, and SF₆ on Silicalite," *Langmuir*, 12, 5888.
- Cutlip, M. B. and Shacham, M.,(2000). *Problem Solving in Chemical Engineering with Numerical Methods*, Prentice-Hall, Inc., New Jersey, pp.112-114.
- Dunne, J.A., Mariwala, R, Rao, M., Sircar, S., Gorte, R.J., Myers, A.L. (1996). "Calorimetric Heats of Adsorption and Adsorption Isotherms. 1. O₂, N₂, Ar, CO₂, CH₄, C₂H₆, and SF₆ on Silicalite," *Langmuir*, 12, 5888.
- Fogler, H. S., (1999), *Element of Chemical Reaction Engineering*, 3rd ed., Prentice- Hall, Inc., New Jersey, 809-887
- Golden, T.C., Sircar, S. (1994). "Gas Adsorption on Silicalite," *J. Colloid Interface Sci.*, 162, 182.
- Harlick, P.J.E., Tezel, F.H. (2002). "Adsorption of Carbon Dioxide, Methane and Nitrogen: Pure and Binary Mixture Adsorption by ZSM-5 with SiO₂/Al₂O₃ Ratio of 30," *Sep. Sci. Technol.*, 37, 33.
- Harlick, P.J.E., Tezel, F.H. (2003). "Adsorption of carbon dioxide, methane and nitrogen: pure and binary mixture adsorption for ZSM-5 with SiO₂/Al₂O₃ ratio of 280," *Sep. Purif. Technol.*, 33, 199.
- Harlick, P.J.E., Tezel, F.H. (2004). "An experimental adsorbent screening study for CO₂ removal from N₂," *Microporous Mesoporous Mater.*, 76, 71.
- Katoh, M., Yoshikawa, T., Tomonari, T., Katayama, K., Tomida, T. (2000). "Adsorption Characteristics of Ion-Exchanged ZSM-5 Zeolites for CO₂/N₂ Mixtures," *J. Colloid Interface Sci.*, 226, 145.
- Koriabkina, A. O., de Jong, A. M., Hensen, E. J. M. and van Santen, R. A.(2005). Concentration and Temperature Dependence of The Diffusivity of n-Hexane in MFI Zeolites,

Micropor. Mesopor. Mater., 77: 119-129

Krishna, R. and Baur, R. (2003). Modelling Issues in Zeolite Based Separation Processes, *Sep. Purif. Technol.*, 33: 213-245

Kärger, J., Pfeifer, H., Stallmach, F., Feokistova, N. N. and Zhdanov, S. P., (1993). ¹²⁹Xe and ¹³C PFG n.m.r. Study of The Intracrystalline Selfdiffusion of Xe, CO₂ and CO, *Zeolites*, 13: 5055

Otto, K., Montreuil, C.N., Todor, O., McCabe, R.W., Gandhi, H.S. (1991). "Adsorption of hydrocarbons and other exhaust components on silicalite," *Ind. Eng. Chem. Res.*, 30, 2333.

van de Graaf, J. M., Kapteijn, F. and Moulijn, J.A., (1998). Zeolitic Membranes in A. Cybulski and J. A. Moulijn (eds): Structured Catalysts and Reactors, Marcel Dekker, Inc., New York 543.

Wirawan, S.K., Creaser, D. (2006). "CO₂ adsorption on silicalite-1 and cation exchanged ZSM-5 zeolites using a step change response method," *Micropor. Mesopor. Mater.*, 91 196.

Yamazaki, T., Katoh, M., Ozawa, S., Ogino, Y. (1993). "Adsorption of CO₂ over univalent cation-exchanged ZSM-5 zeolites," *Mol. Phys.*, 80, 313.
