

The Spatial Transformation and Sustainability of Development in the New City Areas of Metro Tanjung Bunga, Makassar City

Batara Surya¹, Agus Salim², Haeruddin Saleh³, and Emil Salim Rasyidi⁴

¹Department of Urban and Regional Planning, Faculty of Engineering, University Bosowa Makassar City, Indonesia.

²Department of Regional Planning, Faculty of Engineering, University Bosowa Makassar City, Indonesia.

³Department of Regional Economic, Faculty of Economic and Business, University Bosowa Makassar City, Indonesia

⁴Department of Urban Planning, Faculty of Engineering, University Bosowa Makassar City, Indonesia.

Received: 2020-03-27

Accepted: 2021-12-13

Keywords:

spatial transformation;
new metropolitan areas;
land-use change;
sustainable development

Correspondent email:

batara.surya
@universitasbosowa.ac.id

Abstract The spatial transformation of the new city area of Metro Tanjung Bunga Makassar City has an impact on the conversion of productive agricultural land to urban industry. Changes in land use coupled with an increase in socio-economic activities lead to changes in spatial structure, spatial patterns, and a decrease in environmental quality in the direction of changes in the community's socio-economic system. This study aims to analyze: (1) Spatial transformation works as a determinant of the sustainability of the development of new urban areas, (2) The effect of changes in land use, activity systems, population mobility, and transportation systems on environmental degradation. This study uses a combination of qualitative-quantitative approaches sequentially. Data was obtained through observation, in-depth interviews, surveys, and documentation. The number of respondents in this study was determined as many as 250 which was carried out purposively. The results showed that the development of the new city area of Metro Tanjung Bunga which was predominantly developed for commercial activities, services, tourism, and large-scale settlements supported by transportation infrastructure development had an impact on urban sprawl, morphological changes, spatial segregation, and hierarchical differences in meeting the needs of the population. The results of the study indicate that changes in the use of space in the new urban area have led to changes in the single social formation of the local community towards multiple social formations. Furthermore, changes in land use, activity systems, and transportation systems have a positive correlation to environmental quality degradation with a determination coefficient of 60.8%. This study recommends the development of the new city area of Metro Tanjung Bunga towards the creation of social, economic, and environmental sustainability through the support of policies of the Makassar City Government in the future.

©2021 by the authors. Licensee Indonesian Journal of Geography, Indonesia.
This article is an open access article distributed under the terms and conditions of the Creative Commons Attribution (CC BY-NC) license <https://creativecommons.org/licenses/by-nc/4.0/>.

1. Introduction

The economic globalization in the urban development perspective was identified as a factor causing suburbanization and gentrification in metropolitan suburbs. The process was indicated by land-use allocation to various social-economic activities and the increase in population (Giyarsih, 2011; Surya, 2014^b). Global economic activity is not only formed in urban centers but also extends, and ultimately has an impact, on the area surrounding. The global economic restructuring has a profound effect on the socioeconomic population composition of major cities (Sassen, 1991; Utami, 2015; Surya, et al., 2018^a). The vigorousness of Makassar City development as a core conurbation in metropolitan area systems of Mamminasata was characterized by relationship patterns of spatial transformation, city infrastructure, spatial structure, and pattern in the suburb of Mamminasata Metropolitan (Surya, 2018). Development of new metropolitan areas located in a suburb that tends to develop

into pole direction of economic growth was indicated by the increased trade activities, services, recreational media, transporting movement system, sub-urbanization, and increase in public's living standard. The growth of the city towards the suburbs to be developed as a new urban area has an impact on land-use changes towards the complexity of spatial use. The local positive and negative correlation exist simultaneously between the spatial distribution density and the allocation of land-use scale (Giyarsih, 2001; Basant Maheshwari et al., 2016; Qu Yanbo et al., 2018). The density, continuity, cluster degree centralization, and development of the core of the city are indicators of good land allocation. The urban areas changed from a compact city to "more dispersed patterns, or expanded in a compact, a condition which caused changes in spatial structure due to inter-urban connectivity in the periphery (Chang, et al., 2013; Gradinaru et al., 2015).

Dynamic of construction and development of new city area Metro Tanjung Bunga was indicated by transformation from very intensive farming land-use to urban industries, becoming a determinative factor of spatial transformation with a variety of developing morphologies. The three elements affecting city morphology are land use, road patterns, and characteristics of buildings (Hanief, 2014; Surya, et.al, 2018^c). The new municipal growth manifest itself in the urban forms and spatial structures, and the kind of ecological impacts the new growth brings. It is positively associated with changes in the social system and economic system of local communities in the urban suburbs (Sui, et al., 2001; Surya, 2015^c). According to the concept of interconnectivity in typology, landscape connectivity is defined as the continuity of corridors, networks, or matrices in space which characterizes the relationship between ecological systems, such as the overall complexity (Schreiber & Kelton, 2005), accessibility (Janssens, Bruneau, & Lebrun, 2006), interdependency (Haber, 2008), and agglomeration (Wei, Taubenbock, & Blaschke, 2017). Incontrovertibly, maintaining high connectivity is a key factor for protecting biodiversity and maintaining ecosystem stability and integrity (Taylor et al., 1993).

Spatial transformation in the new city area Metro Tanjung Bunga areas through the allocation of social-economic activity land and connectivity to inter-urban of Mamminasata Metropolitan cause changes in structure and the dimensional pattern. The process was indicated by wider areas of large-scale residence development occupying 1,145.82 ha, shopping centers of 216.43 ha, shops of 25.69 ha, tourism services of 40.65 ha, hotels of 10.12 ha, and road construction of 5.07 Km. Facts indicate the addition of linearly and concentrically developing urban centers in the new metropolitan areas has impacted urban sprawl and conurbation as well as a very significant effect on transporting movement systems on hinterland areas. Urban sprawl and associated workplace home distancing may lead to more intensive use of public transportation systems, reducing the dependence on private vehicle travel (Andong and Sajor, 2017). The process of urban-rural element infiltration in a transitional area experiencing intensive change causes urban sprawl (Bryant, et al., 1982; Soussan, 1981; Kustiwan and Pontoh, 2010; Surya, et al., 2018^b). A peri-urban area is described as the effect of land-use change under high anthropic and demographic pressures, and mining operations (Cocheci et al., 2015).

The works relevant to this study include (a) research by Hakim and Parolin (2008) which established rapid urban expansion during the pre-crisis period, mainly in the manufacturing and housing development were converted from significant proportions of agricultural land; (b) a study by Gradinaru et al., (2015) which asserted that the shape of the urban areas changed from being compact to the city with "more dispersed patterns. However, specific processes of urban expansion, such as sub-urbanization or peri-urbanization affect the vast, majority of the analyzed cities influenced by the development level of the urban area; (c) In Indonesia, a study by Winarso et al., (2015) indicated suburb transportation in metropolitan areas increased migrant proportion, change in job structure, number of formal and informal economic activities, and income. This process resulted in a transformation of social-economic structure from agrarian characteristics to urban industries and created

job orientation differences and spatial segregation. The three results of the studies are associated with spatial transformation in the development of the suburb of Mamminasata Metropolitan located in the intersection. This confirms the change in suburb land use due to core city expansion and spatial transformation process caused differences in economic interest and spatial segregation in a suburb of Mamminasata Metropolitan.

This study contributes to the development of new urban areas in the case of metropolitan cities. This means that the dynamic development of a metropolitan city coupled with spatial transformation has an impact on changes in the use of space as a result, of increased commercial activities, services, tourism, and other socio-economic activities as well as their influence on changes in the social formation of local communities. Thus, this study is aimed at answering research questions, namely: (1) How does spatial transformation work as a determinant of the sustainability of the development of new urban areas? (2) How will changes in land use, activity systems, population mobility, and transportation systems affect the environmental quality of the new city area?

2. Methods

Spatial transformation in the new city area Metro Tanjung Bunga is determinant area expansion from Makassar City to the suburb of Mamminasata Metropolitan. The intensity of development is indicated by environmental degradation, change in spatial structure, pattern, and social-economic systems of the local community. In this paper, a case study was chosen to analyze and describe the spatial transformation, its impact, and conceptual idea of sustainable development in the new city area Metro Tanjung Bunga. According to the focus of the exercise, this was a naturalistic, holistic, and phenomenological study (Densin and Lincon, 2009; Creswell, 2016; Sugiyono, 2016).

In this work, a case study was utilized to examine the conditions and characteristics of spatial transformation, occurring impact, and sustainability of development in the new city area Metro Tanjung Bunga. The case study was chosen considering that (a) pattern of spatial transformation in the new metropolitan areas is specific. (b) a case study has prominent consistency and sequence. (c) It is sufficiently complex. (d) It is intended to help understand the background of an event occurring in process of development in the new city area Metro Tanjung Bunga. The research was conducted from January to November of 2017 in the new city area Metro Tanjung Bunga (Figure 1). It used a combination of qualitative-quantitative approaches. Philosophically, the reasons for combining the approaches are (1) logics of triangulation, in which the results of the qualitative study were rechecked in quantitative study vice versa; (2) quantitative and qualitative studies were combined to give general description; (3) quantitative technique was utilized in structural properties of social life, while qualitative approach took the quality of subjects as a starting point so that both approaches were presented together in conducting the study; (4) quantitative approach was utilized to analyze the correlation between changes while qualitative approach helped to harmonize factors underlying the correlation; (5) quantitative method was utilized to express structural characteristics of social life in large scale, while the qualitative approach was utilized to examine behavior in small scale. When pursued to express both levels, quantitative-qualitative

approaches were utilized together; and (6) data collection of two different realities needed a combination of both approaches. The study locations are presented in Figure .

In this study, data collection methods included (a) observation to note spatial transformation, change in land use, spatial structure and pattern, and impact on change in the environmental ecosystem; (b) survey to understand and assess respondents' perception associated with changes in social, economic, and hierarchical systems in order, to fulfill the needs of the local community; and (c) documentation to collect data associated with the study conducted in the new city area Metro Tanjung Bunga. The data were analyzed through the following methods: (i) qualitative data were categorized while quantitative information, were examined by statistical-descriptive analysis; (ii) both data were interpreted by triangulation or between methods. The analysis was carried out interactively and continuously until the data was saturated and complete. The data were analyzed during and after the collection of data to obtain similar responses to the respondents' views associated with conditions developing in the new city area Metro Tanjung Bunga. When interviewing, the responses of respondents up to a certain stage were analyzed to enhance data credibility.

Generally, the analysis involved data reduction, display, and conclusion drawing/verifying. The process of combined qualitative-quantitative approaches was as shown in Figure 2.

Method for Collecting Data

The data in this study are divided into two categories, namely primary data and secondary data. Primary data in this study were obtained through observation, in-depth interviews, and questionnaires. Meanwhile, secondary data was obtained through documentation of the relationship between spatial transformation and land-use changes in the new city of Metro Tanjung Bunga Makassar City. Furthermore, the data collection method in the study was divided into two stages, namely qualitative and quantitative data. (1) Qualitative data are obtained through field observations, in-depth interviews, and documentation. The main instrument in qualitative research, namely the researcher himself acts and plays a role in the data collection process, determines the research focus, and selects key informants as data sources. The results of the data are then used to describe the spatial transformation and changes in land use as a determinant of the sustainability of the development of the new city area Metro Tanjung Bunga. The

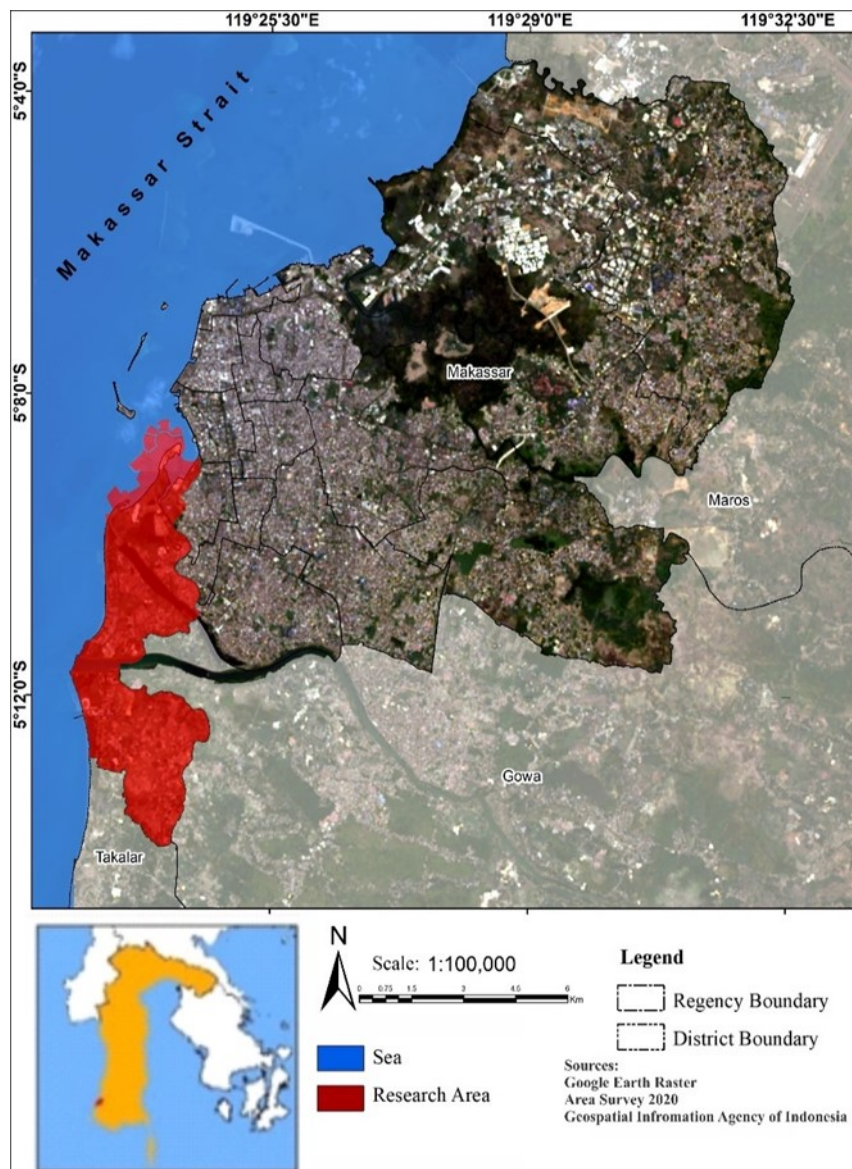

Figure 1. The new city area of Metro Tanjung Bunga, Makassar City as Study Object.
Source: Bappeda of Makassar City, 2017

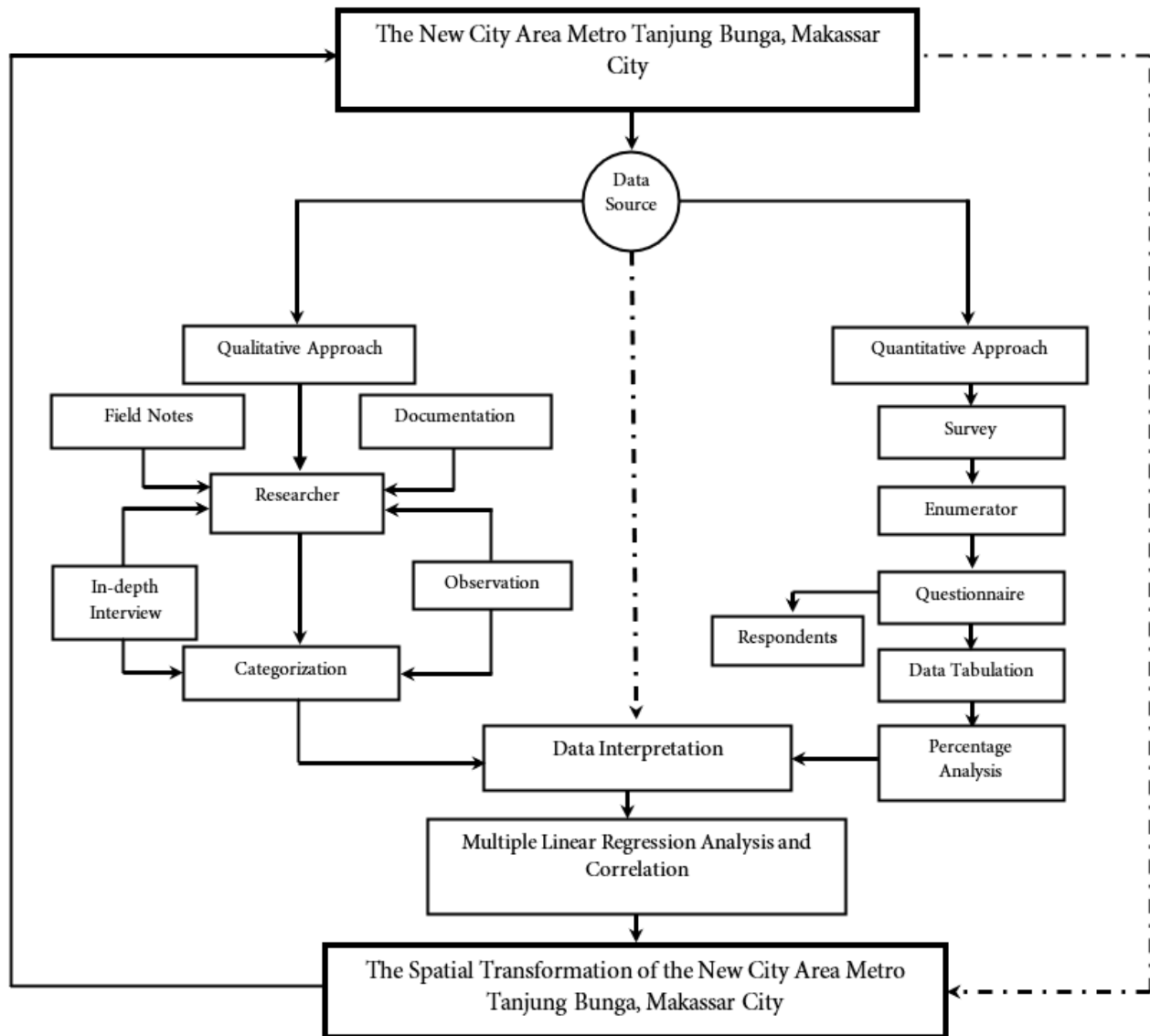

Figure 2. Combination of qualitative and quantitative approaches in Sequential
Source: Adapted from (Saefullah, 1993), with Modification

results of data collection are then presented in the form of descriptions and categorizations. (2) Quantitative data is obtained through a survey using a questionnaire instrument. The data is used to describe the effect of changes in land use, activity systems, population mobility, and transportation systems on environmental degradation. The results of data collection through questionnaires are then presented in tables and diagrams.

Observation

The instruments used in data collection through observation in this study, namely field notes, periodical notes, cameras, and checklists. The observations in this study are used to trace data on the spatial transformation of the new city area of Metro Tanjung Bunga, namely (i) the urban system, (ii) the environmental system, (iii) the economic system, and (iv) the social system of the immigrant population and local communities. Furthermore, the data obtained through observation is used to compare the dynamics of changes in the new urban area to be associated with the assumptions and theories used as the reference in this study. Furthermore, observations are also used to observe the behavior of the people living in the new city area Metro Tanjung Bunga based on the developing field situation

and to record findings that allow or qualify for use in interpretation and analysis.

In-Depth Interviews

Data collection through in-depth interviews in this study was used for two purposes, namely (i) describing the situation and conditions of the new city area Metro Tanjung Bunga Metro, and (ii) explaining and describing the efforts made by local communities in responding to changing situations in the environment where they live. The main subjects in the in-depth interviews in this study, namely local government, immigrants, and local communities. Furthermore, the instruments used in in-depth interviews are a tape recorder and an interview guide equipped with freelance notes and a checklist. In-depth interviews in this study were used to trace data, namely (i) government policies related to the development of the new city area of Metro Tanjung Bunga, (ii) local communities related to efforts made to meet basic needs, (iii) social relationships built between local communities and immigrants, (iv) immigrants in relation to established economic relations, (v) land ownership, and (vi) land values and prices. The data obtained through in-depth interviews were then categorized for interpretation purposes in order to show differences in the

conditions of local communities and immigrants before and after the spatial transformation in the new city area of Metro Tanjung Bunga Makassar City.

Questionnaire

The data collected through questionnaires in this study were used for two functions, namely (1) descriptive, describing the conditions and characteristics of the spatial transformation of the Tanjung Bunga Metro area, and (2) measurement, in this case referring to the characteristics of the data obtained in the field. Measurement of data obtained through a questionnaire in this study using an ordinal scale. The questions posed to respondents are divided into two categories, namely structured and unstructured. The questionnaire in this study was used to trace data, including (1) Land use change, measured by indicators, namely the type of activity, the area of land built, and the allocation of spatial use; (2) The activity system is measured by indicators, namely activity patterns, spatial structures, and spatial patterns; (3) Population mobility is measured by indicators, namely the origin and destination of the movement, accessibility, and the mode of transportation used; (4) The transportation system is measured by indicators, namely activity patterns, network systems, and movement systems; (5) Environmental quality degradation is measured by indicators, namely potential pollution, sources of pollution, and carrying capacity of the environment. The measurement scale used for the data obtained through the questionnaire is divided into two categories, namely: First, the measurement uses an ordinal scale to show categories based on parameters and ratings, namely a value of 5 for the very supportive category, a value of 4 for the supportive category, a value of 3 for the sufficient category supportive, the value 2 for the category less supportive, and number 1 for not supportive. Furthermore, the measurement results then produce quantitative data for use in statistical analysis.

Filling in the questionnaire in this study was not submitted directly to respondents but was guided by researchers and enumerators. Respondents were selected by the enumerator who was in, the charge of collecting data in the field. Enumerators were selected based on the following considerations: (1) Local people who have the ability, to collect data; (2) Understanding the situation and socio-economic conditions of the community; (3) being Close to local communities and migrant residents. Before carrying out their duties in the field, the enumerators were given directions and exercises in filling out the questionnaire as well as techniques for conducting interviews with respondents. The questionnaires were distributed to the new city area of Metro Tanjung Bunga Makassar City. The reason the researchers determined the location was based on the condition of the development of the new city area Metro Tanjung Bunga which is currently inhabited by immigrants and local communities. Furthermore, the criteria for respondents who filled out the questionnaire in this study were (i) immigrants, (ii) local communities, (iii) already married, and (iv) living in the new city area Metro Tanjung Bunga for five years.

Documentation

The documentation data used in this study is related to the development of the new city area of Metro Tanjung Bunga Makassar City. The documents referred to include: (1) Data on the population of the new city area of Metro

Tanjung Bunga obtained through the Makassar City Statistics Agency, (2) The socio-economic profile of the immigrant population and local communities is obtained through the District Office; and (3) The policy document for the development of the new city area of Metro Tanjung Bunga was obtained from the Makassar City Regional Development Planning Agency. These three types of documents are used to support data from in-depth interviews, observations, and questionnaires.

Determination of Research Informants and Respondents

The main source of qualitative data in this study is informants. The informants were determined using the snowball method. This means that in this study, the researcher determines the key informant earlier based on information obtained from community leaders. The key informants selected were community leaders who were able to provide good information about the development of the new city area Metro Tanjung Bunga Makassar City. The next step is to find out who other community leaders can be interviewed, whose information was obtained from key informants. The aim is to get the same information and description about the situation and development of the new city area Metro Tanjung Bunga. Apart from informants, several respondents who were previously interviewed were also assigned as informants. The aim is to explore several questions that require a more detailed explanation based on the results of the questionnaire that has been obtained. Thus, the selected informants are immigrants and local communities who are in the location of the new city area Metro Tanjung Bunga of Makassar City. Referring to the snowball method used, the number of informants was determined to be 16 people, 10 from outside the respondents, namely the local government, and community leaders, and 6 informants from the respondents. 6 informants from the respondent respondents were selected based on criteria, namely: (1) Having a case in the family regarding the sale of land; (2) Has a large enough land before the new area Metro Tanjung Bunga was built; (3) Land is used for socio-economic activities; (4) The relationship within the informant's family is still ongoing; and (5) Able to provide good information about the location where he lives. The snowball method used in this study is presented in Figure 3.

The research sample in this study was determined using a purposive sampling method, which the researcher determined based on certain characteristics, namely the

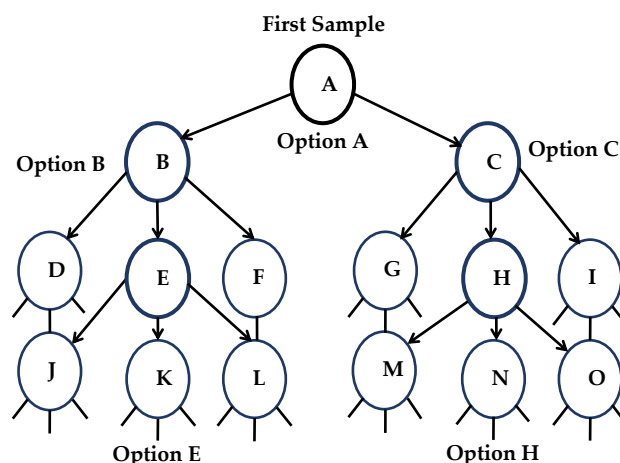

Figure 3. Schematic of the snowball sampling technique

sample (respondents) were immigrants and local communities. Furthermore, the results of the questionnaire obtained were analyzed using statistics, percentages, and frequency values. Sampling refers to Cochran (1991) with the following formulations:

$$n = Z^2 \alpha P Q / d^2$$

where n is the sample, Za is the standard deviation for 1.96 with a coefficient value of 95%, P is the proportion of subjects, Q is 1, P = 0.5, and d is the degree of accuracy used, which is 0.15. The appropriate number of samples was determined to be 250.

Data Analysis

The data analysis in this study consisted of two stages. First, the data were analyzed using a qualitative approach. This means that the data collected through observation and in-depth interviews are then analyzed. Second, analyzed the data using a quantitative approach. This means that the data was collected through a questionnaire, then analyzed using quantitative descriptive statistics, correlation, and multiple regression. The two data obtained were analyzed by combining qualitative and quantitative approaches. The two types of data are then interpreted using triangulation, in this case, the data obtained through a questionnaire is then developed using qualitative and quantitative methods. This combination is intended to strengthen the validity of the analysis results.

Qualitative Data Analysis

Qualitative data analysis was carried out during the data collection in the field and after the data collection was complete. During the in-depth interview, the researcher has conducted an interactive analysis of the answers obtained from the informants. The qualitative approach to data analysis is divided into three categories, namely data reduction, data presentation, and conclusion drawing. Data reduction is carried out with the following considerations: (1) the data obtained in the field is quite large, complex, and complicated, so that data reduction and similar data grouping are required for interpretation needs; (2) main findings are identified and summarized, focusing on important aspects, themes, and patterns, then formulating conclusions; (3) the reduced data is then used to provide a clear picture based on the focus and objectives of the study; (4) Data reduction is done by providing codes for certain aspects following the objectives to be achieved in this study.

After the data is reduced, the next step is to display the data. The steps taken include: (1) Quantitative data is presented in tables and graphs, to facilitate understanding and interpretation. (2) Qualitative data is presented in the form of a brief description, chart, and the relationship between categories concerning the theory used; (3) data is presented in text and narrative form for easy understanding; (4) the data displayed is arranged sequentially using letters and numbers so that the structure can be understood for the needs of in-depth analysis based on the focus and purpose of the study. Furthermore, qualitative data analysis in this study was carried out in the field and during the data collection process. The activities carried out by researchers were separating information into categories, coding, creating information in a story, and presenting writing qualitatively.

That is, qualitative data analysis is not rigorously tested or measured in terms of quantity, intensity, and frequency values.

Quantitative Analysis

Quantitative analysis in this study is used to answer research questions, namely the effect of changes in land use, activity systems, population mobility, and transportation systems on environmental degradation. Multiple regression analysis is used to determine how much influence the independent variables X₁ (changes in land use), X₂ (activity systems), X₃ (population mobility), and X₄ (transportation systems) have on the dependent variable Y (environmental degradation). Thus, multiple regression analysis is used to predict the value of the dependent variable when all the independent variables have known values. The multiple regression analysis models is presented in Figure 4.

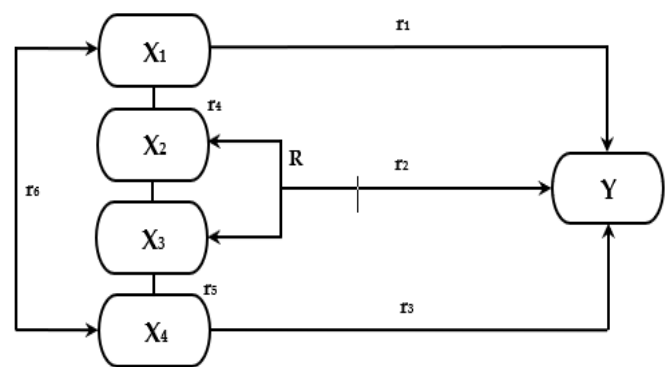

Figure 4. Model of multiple regression.

A multiple variable relationship model with four independent variables—X₁, X₂, X₃, and X₄—and one dependent variable, Y, was developed, to determine the relationships of X₁ with Y, X₂ with Y, X₃ with Y, and X₄ with Y. Those of X₁ with X₂, X₂ with X₃, X₃ with X₄, and X₁ with X₄ were determined using a simple correlation technique. The relationship of X₁ together with X₂, X₃, and X₄ with Y was determined using multiple correlation. This model includes four independent variables (X₁, X₂, X₃, and X₄) and one dependent (Y). The analytical formulations used are as follows:

$$Y = \alpha + \beta_1 X_1 + \beta_2 X_2 + \dots + \beta_n X_n + \epsilon$$

$$r_{xy} = \frac{\sum xy}{\sqrt{(\sum x^2)} \sqrt{(\sum y^2)}}$$

Where Y is the dependent variable, α is a constant, X₁, X₂, X_n is the independent variable β₁, β₂, β_n is the regression coefficient, and ε is the error or residue. Furthermore, r_{xy} is the correlation coefficient between variables X and Y, x is the deviation from the mean for the value of variable X, y is the deviation from the mean for the value of variable Y, Σxy is the number of times the value of X and Y, x² is the square of the values x and y² is the square of the y value.

3.Results and Discussion

Spatial transformation in New City Area of Metro Tanjung Bunga

In 2017, the built areas in the new city area Metro Tanjung Bunga occupied 1,716.94 ha of land and commercial-economic activities dominated the region. Field facts found indicate that a decrease in the productivity of agricultural land is positively associated with a shift in the orientation of the work of the local community towards urban industrialization. Noted how agriculture in these areas could contribute key services emanating from environmental, social, and economic functions in response to the consumption-oriented need of urban society (Vizzari, et al., 2015). The spatial transformation in the new city area of Metro Tanjung Bunga of Makassar City has an impact on changes in spatial attributes in the suburb of the Metropolitan Mamminasata. The spatial attributes of the city changing in the industrial model encourage the formation of cultural and creativity centers reflecting vitality for various social-economic opportunities (Inoguchi et.al, 2015; Surya, 2018). Thus, land-use changes in the new city area of Metro Tanjung Bunga have an impact on suburbanization and gentrification in the suburban area. This process is indicated by the flow of capital and investment in residential development, tourism, trade, infrastructure, and other commercial activities. An increase in activities creates very intensive spatial interaction with the urban system being a driving force to mobilize immigrants from near areas. The spatial interaction physically, economically, and socially changes into urban conurbation, integrating the infrastructure systems in small surrounding cities. Interregional is influenced by transportation facilities and the flow of people, goods, and services (Hurst, 1974; Surya, 2015^d). Therefore, land allocation and spatial use indicate that the dominant large-scale commercial and settlement functions have caused the new urban area of Metro Tanjung Bunga to develop towards a new growth pole and urban agglomeration within the Mamminasata Metropolitan area. This process led to the formation of a new service center to support the function and role of Makassar City as the core city in the Mamminasata metropolitan urban system. The

changes in the use of space in the new city area of Metro Tanjung Bunga are presented in Table 1.

Dynamics of spatial transformation (see Table 1) are caused by the following two factors: (a) process of spatial-physical development occurring centrifugally and (b) spatial-physical growth happening centripetally. Centrifugal spatial development is the determinative factor of population mobilization and widening new urban centers to suburban areas surrounding, to ensure control is required in one compact, safe, and efficient urban system unit. Land transformation into urban residences, industries, trade, and growth of population causes the land price to raise, and this has impacts on the surrounding urban area characteristics (Yunus, 2005; Parasati, 2011; Sugiana, 2011; Singh et.al, 2016). Thus, the development of the new city area Metro Tanjung Bunga is an expansion process and spatial addition of Makassar City to the suburban area of Mamminasata Metropolitan. The process directly decreases the quality of the environment, changes in spatial structure, spatial pattern, and morphology of suburban areas. Dominant pattern changes in function spatially cause formal and informal economic activities to develop in the new city area Metro Tanjung Bunga. The change in spatial function and suburban land use transformation is positively associated with adjustment from production to urban space reproduction (Lee, 1979; McGee, 1997; Yunus, 2008; Surya, 2014). This means of the new city areas of Metro Tanjung Bunga plays a strategic role in integrating systems of social-economic activities in a wider urban scale relative to the spatial polarization of Makassar City. The effective polarization between the city and countryside, and the existence of interdependence among demographic processes, socio-economic and residential development in the urban has a direct impact on the connectivity of the metropolitan transportation system. The population growth requires the continued search for residential space. The urbanization of natural lands is an inevitable process but does not have to be accomplished without regard for environmental quality (Prados, 2009; Surya, 2016). Therefore, economic polarization in the new city area Metro Tanjung Bunga has a direct impact on residential development, changing local

Table 1. Change in land-use in the new city area of Metro Tanjung Bunga, from 2010 to 2017

2010	Land Use Change			2017	Land area (ha)	%	Description
	Land area (ha)	%	Land area (ha)				
Trade/commerce	7.56	0.80	Trade/commerce	242.12	14.10	Increasing	
Education	1.50	0.16	Education	15.89	0.93	Increasing	
Residence	122.51	12.93	Residence	1145.82	66.74	Increasing	
Health	1.50	0.16	Health	1.50	0.09	Static	
Tourism	11.62	1.23	Tourism	40.65	2.37	Increasing	
Office	1.16	0.12	Office	9.56	0.56	Increasing	
Sport media	3.20	0.34	Sport media	14.56	0.85	Static	
Social facility	11.00	1.16	Social facility	30.39	1.77	Increasing	
Hotel	-	-	Hotel	10.12	0.59	Increasing	
Mixed wet field and garden	160.00	16.88	Mixed wet field and garden	25.15	1.46	Decreasing	
Pond	108.00	11.39	Pond	79.14	4.61	Decreasing	
Empty land	519.76	54.84	Empty land	102.04	5.94	Decreasing	

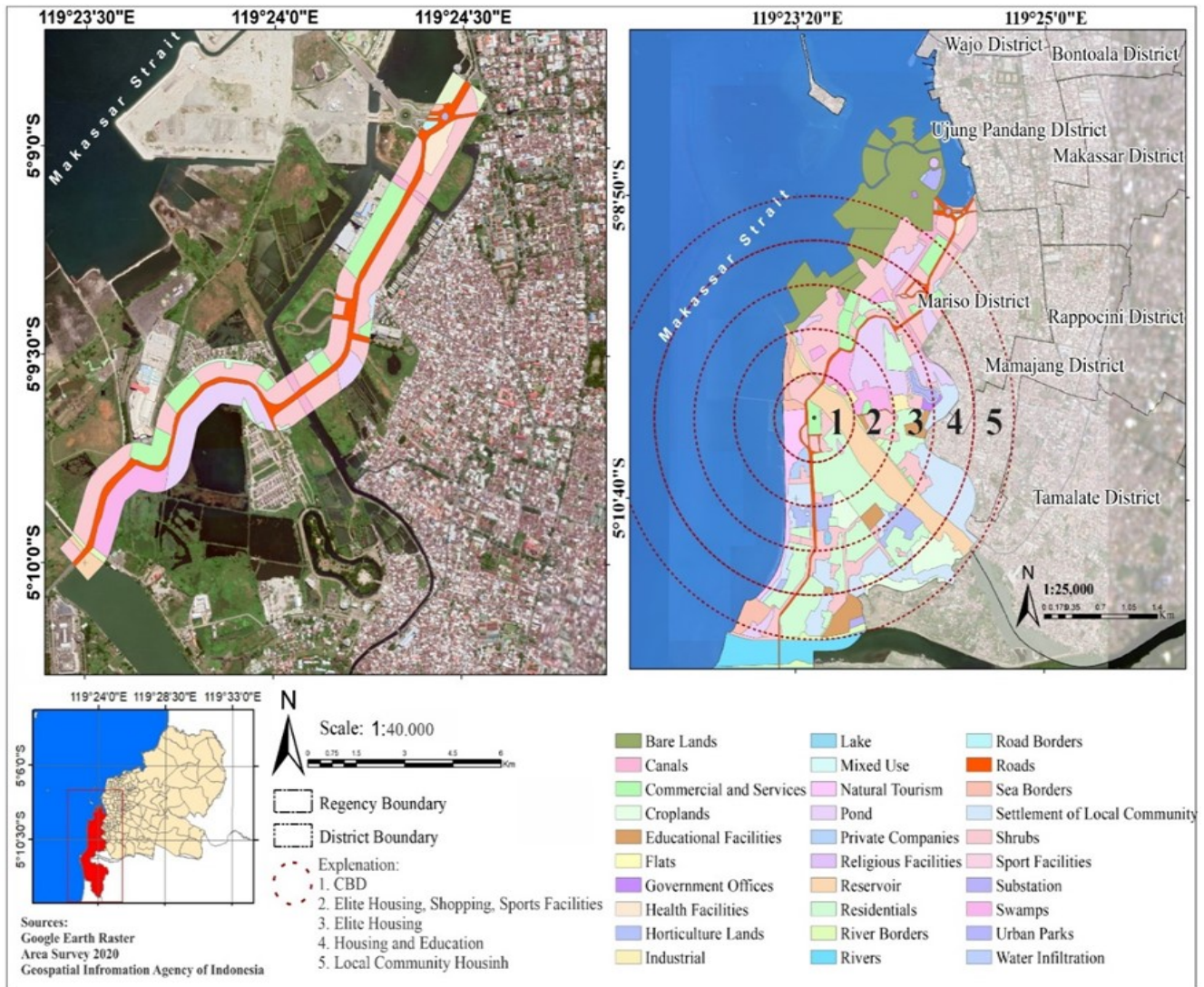

Figure 5. Spatial linear and concentric physical development

characteristics of the surrounding environment and developing into the integration of the Mamminasata Metropolitan urban system.

Linearly and concentrically spatial physical development (see Figure 5) in the new city area Metro Tanjung Bunga is an urban area development in the built areas. It leads to integration through accumulation of commercial activities where the central point is indicated by Mall GTC. There are three established spatial zones (see Figure 6) including (1) the main zone in where people with high social-economic status occupy. It is indicated by complete social-economic services and dominated by new individuals consisting of ruling elite group, professionals, and “businessmen”. This group consists of expansively entering people, who are dominant investors with land, having political power, high income, and living in very luxurious residences in the new city area of Metro Tanjung Bunga, Makassar City; (2) the area between zones 1 and 3 is location which workers occupy, enter and commune with local community. The individuals here are of commercial economic businesses and have higher income than those in zone 3; and (3) the local community with low social-economic status occupies the outer zone (zone 3). Ordinarily, the residences include very simple stage houses, and their instruments tend to be slums. In consequence, the developing residential areas indicate a difference of inter-zone spatial use aspects and mixing between formal and informal residences, and experiences rapid population

growth. Besides, the core areas are experiencing population stagnation and reduction as a part of the mega-urbanization process (Firman, 2004; Yunus, 2006; Setioko, 2009). Housing development tends to form new residential clusters based on economic class, resulting in differences in stratification and social status between individual immigrants and local communities (Surya, 2016). The suburbanization of poverty is caused not only by direct moves but also broader indirect and exclusionary processes attributable to the increasing unaffordability and inaccessibility of central city locations. This broader process reflects the changing topography of the urban regions marked by shifting socioeconomic divides (Hochstenbach and Musterd, 2018).

The increasing capital flow and investment relative to gentrification in the New Metropolitan reposition role of land economic value is not based on the potential farming products and land width. The evidence indicates land price/m² before developing of the new city area of Metro Tanjung Bunga ranged from Rp.50,000 to Rp.100,000 with a valuation based on farming land productivity and width. Furthermore, change based on economic land productivity and price/m² ranged from Rp.3,500,000 to Rp.5,000,000. This condition indicates land and space experienced changes from local community ownership to investors, ruling elites, and capitalist classes. This means the current space and land are considered commodities that may be reproduced and traded, and domination is determined by income and capital

ownership (Harvey, 2009; Surya, 2015^a). Thus, the nearer the residential location distance to main central and economic activities, the higher the value and price of land and vice versa. Therefore, land productivity will be determined mainly by locational sites based on the economic spatial functions. The intensity of development increases dominantly in economic activities and large scale, residences are positively associated with spatial domination inequality, stratification difference, and social classes between the comers and the local community.

There are six issues associated with spatial zone division and functions developing in the new city area Metro Tanjung Bunga. These are (1) transformation of spatial use; (2) change in residential building characteristics; (3) adjustment in residential pattern; (4) social interaction and adaptation between the comers and local community; (5) gentrification and suburbanization in suburban areas; and (6) physical, economic, and social segregation. These indicate the allocation of built spaces based on spatial zone has a positive impact on changes in accessibility, population mobility and it is a driving factor for the entrance of comers expansively. Information from the field indicates the large scale, residences are dominantly occupied by middle and high individuals with luxury residential types in one hand. In contrast, the local community occupies slums with the stage-house model which appears to be changing into slums. The

parameters used to evaluate slums include (1) residential condition and building esthetic do not comply with requirements of health and low-income people occupy these residences; (2) inability to access the resources in urban space; (3) scarce instruments and infrastructures of residences; flood vulnerability relative to insufficient drainage network infrastructures; (5) vulnerability to fire threat relative to poor roads; and (6) low accessibility relative to non-patterned and very limited road systems. The growth of slums was not a wholly organic development that occurred within the domestic conditions of a country, rather it is one of the results of globalized, neoliberal capitalism (Almeida, 2013). As a result, the spatial transformation and change in its use result in physical, economic, and social segregation.

Spatial change and the inability to reproduce urban space make it hard for the weak local community to access economic and land resources, triggering the development of slums (See Figure 7). The development of slums is triggered by internal factors such as culture, religion, workplace, birthplace, length to reside, house investment, type of homebuilding. It is also influenced by external factors such as land ownership and governmental policy (Srinivas, 2012). The institutional discrimination of community groups associated with land ownership is the main reason for the development of informal residences or Squatters (Zhao, 2015). There are three types of expressions associated with spatial transformation in the new city area Metro Tanjung Bunga. These are: (a) social rank shown by change in economic status of the community to be societal positions with order based on specialization and collective prestige; (b) urbanization evidenced by change in family economic status, increasing from traditional lifestyle to urban way of life; and (c) segregation, having tendency to change in ethnic status of certain groups characterized by difference in wealth and residence instrument ownership. The change in occupational relationship pattern of traditional agrarian people moves to work-related relationship pattern of contractual-urban industrial society (Yunus, 2006; Surya, 2016). The direct impact is change in social solidarity, from mechanistic to organic cohesion (Kolip and Setiadi, 2011; Martono, 2014; Surya, 2014^b). The field observations show the inability of local community to adapt to environmental change stimulus relative to spatial change in development causes local community to exist in marginal position. This conclusion was made based on the indicators of residential instrument ownerships and difficulties in getting a proper job, and therefore categorized as urban poor society. Other information gathered from the field indicate job orientation which the local community achieves are categorized into two main classes, (a) urban formal activities, as security in luxury residences developed, office boy in commercial economic activities; and parking workers in advanced commercial economic activities; (b) urban informal activities such as house-helping in elite households; street peddlers, vegetable suppliers, and construction workers. The hierarchy of human need levels is measured using the five indicators, (1) physiology consisting of clothing, food, residence, sex, and individual prosperity; (2) safety comprising job security; (3) social, entailing the need to be accepted by others, respect, achievement, and participation in an activity; (4) self-esteem, which include internal appreciations such as autonomy and achievement, and external factors such as status,

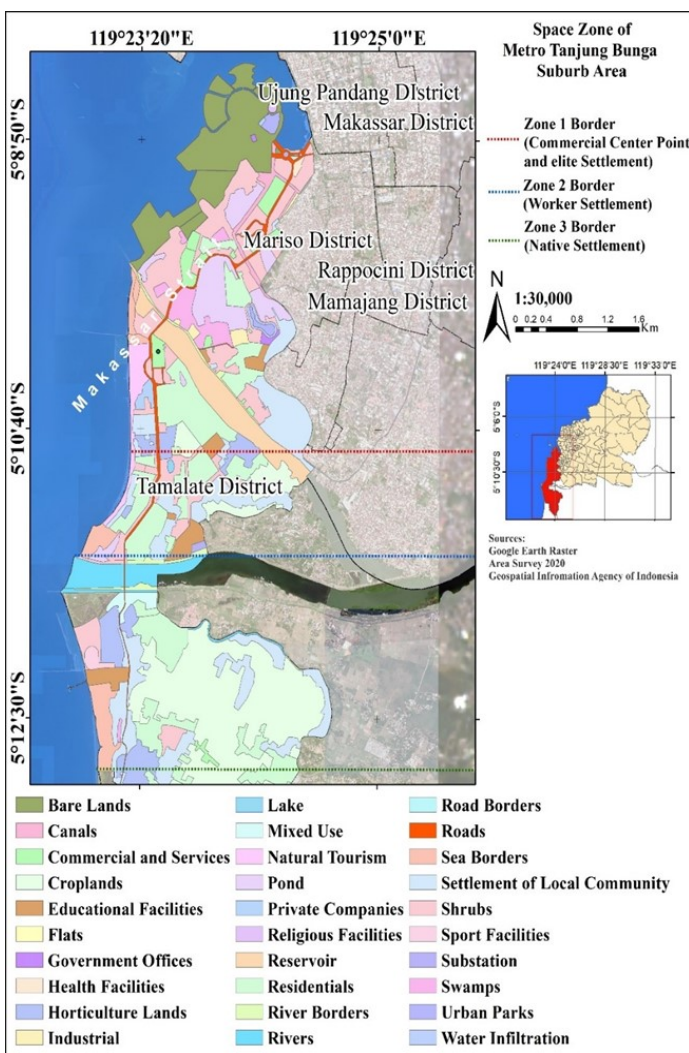

Figure 6. Spatial Zone of the new city area of Metro Tanjung Bunga

acknowledgment, and care; and (5) self-actualization, consisting of motivation to be an individual based on capability, one's growth achievement and self-sufficiency (Maslow, 1994; Hariyono, 2010). To support these facts, a hierarchy of need fulfillment is measured based on the perception of the local community.

Spatial change and the inability to reproduce urban space make it hard for the weak local community to access economic and land resources, triggering the development of slums (See Figure 7). The development of slums is triggered by internal factors such as culture, religion, workplace, birthplace, length to reside, house investment, type of homebuilding. It is also influenced by external factors such as land ownership and governmental policy (Srinivas, 2012). The institutional discrimination of community groups associated with land ownership is the main reason for the development of informal residences or Squatters (Zhao, 2015). There are three types of expressions associated with spatial transformation in the new city area Metro Tanjung Bunga. These are: (a) social rank shown by change in economic status of the community to be societal positions with order based on specialization and collective prestige; (b) urbanization evidenced by change in family economic status, increasing from traditional lifestyle to urban way of life; and (c) segregation, having tendency to change in ethnic status of certain groups characterized by difference in wealth and residence instrument ownership. The change in occupational relationship pattern of traditional agrarian people moves to work-related relationship pattern of contractual-urban industrial society (Yunus, 2006; Surya, 2016). The direct impact is change in social solidarity, from mechanistic to organic cohesion (Kolip and Setiadi, 2011; Martono, 2014; Surya, 2014^b). The field observations show the inability of local community to adapt to environmental change stimulus relative to spatial change in development causes local community to exist in marginal position. This conclusion was made based on the indicators of residential instrument ownerships and difficulties in getting a proper job, and therefore categorized as urban poor society. Other information gathered from the field indicate job orientation which the local community achieves are categorized into two main classes, (a) urban formal activities, as security in luxury

residences developed, office boy in commercial economic activities, and parking workers in advanced commercial economic activities; (b) urban informal activities such as house-helping in elite households; street peddlers, vegetable suppliers, and construction workers. The hierarchy of human need levels is measured using the five indicators, (1) physiology consisting of clothing, food, residence, sex, and individual prosperity; (2) safety comprising job security; (3) social, entailing the need to be accepted by others, respect, achievement, and participation in an activity; (4) self-esteem, which include internal appreciations such as autonomy and achievement, and external factors such as status, acknowledgment, and care; and (5) self-actualization, consisting of motivation to be an individual based on capability, one's growth achievement and self-sufficiency (Maslow, 1994; Hariyono, 2010). To support these facts, a hierarchy of need fulfillment is measured based on the perception of the local community.

Proposed interpretations are seen in Figure 8 and include (i) relation between spatial transformation and change in its use against physiological fulfillment of local community indicates that 5.33% of them responded "very satisfactory", 13.11% "satisfactory", 70.08% "less satisfactory" and 11.48% responded "unsatisfactory". Thus, spatial transformation and very rapid change in spatial use indicate a difference in physiological need fulfillment of the local community. (ii) The relation between spatial transformation and change in spatial use to safety fulfillment for local community indicates 40.57% answered "less satisfactory" while 13.52% answered "unsatisfactory". Therefore, spatial transformation and change in spatial use indicate the difference from the safety fulfillment of the local community. After this fact was confirmed, it was evident safety was only felt by the local community whose members were involved in social-economic activities. (iii) In spatial transformation and change in spatial use for social relation fulfillment 12.3% "very satisfactory"; in this case, social relation is built between the comers and the local community and worked well. In the same regard, 29.92% were "satisfactory"; in this case, social relation is built if necessary; 46.31% opted for "less satisfactory"; while 11.48% chose the "unsatisfactory" option. This information indicates social relations work well



Figure 7. Slum Residence in new metropolitan areas of Metro Tanjung Bunga

only place in the residential environment of the local community and especially in infiltrative comers.

A positive pattern of relationships between communities helps in developing mutually beneficial social relationships to improve welfare and being in a single residential environment. Space is a very important prerequisite in developing cultural and spatial identities as media to implement the hierarchical process. Furthermore, social capital is a collection of sources binding to family relation and social organization of community which is useful for cognitive and social development of children and youths (Ahmed, 2011; Coleman, 2011) (iv) Spatial transformation and change in spatial use for self-esteem need fulfillment in the local community. In this regard, 11.07% of the respondents chose “very satisfactory”, 21.72% “satisfactory” and were proud residents. On the same basis, 54.51% of the respondents opted for “less satisfactory” while 11.89% of them chose “unsatisfactory”. This implies the pride as residents in the New Metropolitan Areas was only felt by a few of members of the local community. (v). Spatial transformation and changes in spatial use show the self-actualization ability of local communities at 10.25% of the respondents chose “very satisfactory”; 23.36% of “satisfactory”; 54.51% “less satisfactory”; and 12.70% of them were “unsatisfactory”. Therefore, spatial transformation and change in spatial use do not have a direct effect on the development of economic business improved as a form of self-actualization of the local community. The five analyzed aspects indicate the spatial transformation and change in spatial use do not have a direct effect on the existence of local community in the new city area Metro Tanjung Bunga. A positive contribution was only given to social relations between the local communities and the infiltrative comers while the other four aspects tended to weaken in fulfilling the needs of the local community. The community’s ability to stay in the urban environment is associated with their capacity to adapt or modify their behavior in dealing with the availability and distribution of resources since decision making is required (M.J. Weaving, et.al 2014). The relationship between decision-making and the strategic

group should integrate into the organization's various needs and demands of the community (Salusu, 2014). For this reason, spatial transformation and change in spatial use are positively associated with marginalization and poverty in the local community. The two emanate from the impact of the development in the new city area of Metro Tanjung Bunga.

Spatial transformation and change in spatial use indicate a certain portion of land has the potential to affect others near it and expand to the surrounding areas in urban systems of metropolitan of Mamminasata. There are two stages in the dynamics of development in the new city area of Metro Tanjung Bunga, namely (a) dominance of economic activities to small cities and surrounding rural areas; and (b) combination of activity patterns in the urban system of Mamminasata Metropolitan. These two factors cause the morphological changes indicated by the change in urban structure and city form in metropolitan spatial scale (Friedman, 1975; Yunus, 2006; Surya, 2018). Moreover, further evidence from the field indicates large-scale residence development and regional scale economic activity functions have an impact on the integration of surrounding urban areas and are positively associated with poverty in the local community. Poverty facing people is not only caused by the process of urban involution and inability to access economic resources, but also by land dominance by capitalists (Berger, P.L., 1984; Armstrong, W.R., and McGee, 2002; Hariyono, 2010). Friedman (1988) called the facts collective, eternality or spill-over effect phenomena (Briant et.al, 1982; Yunus, 2008) while McGee (1997), referred to it as transboundary effect phenomena. Schematically, the process of spatial transformation in the new city area Metro Tanjung Bunga, is as shown in Figure 9.

The impact of spatial transformation in the New City Areas of Metro Tanjung Bunga

Spatial transformation and changes in spatial use are determining factors for the spatial expansion of Makassar City towards the suburban area of Metropolitan Mamminasata. Direct impacts of the process results include (1) increasing amount and density of population; (2)

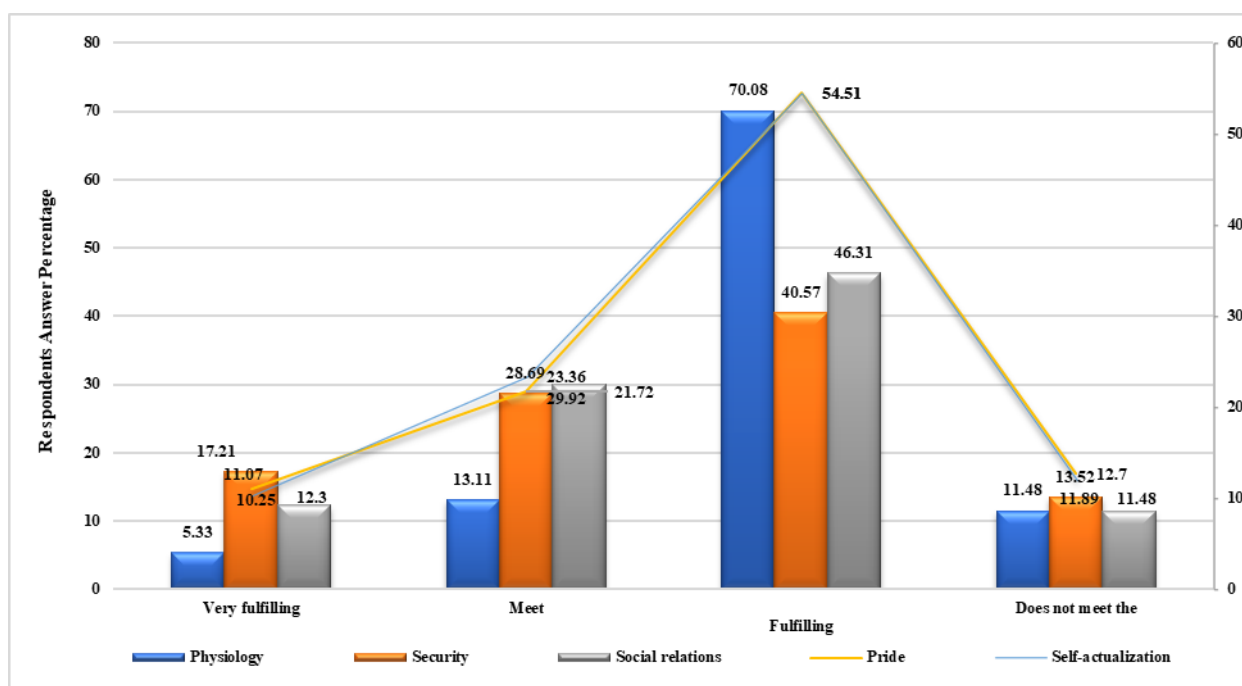

Figure 8. Hierarchical graph of fulfilling the needs of local communities in the new city area of Metro Tanjung Bunga

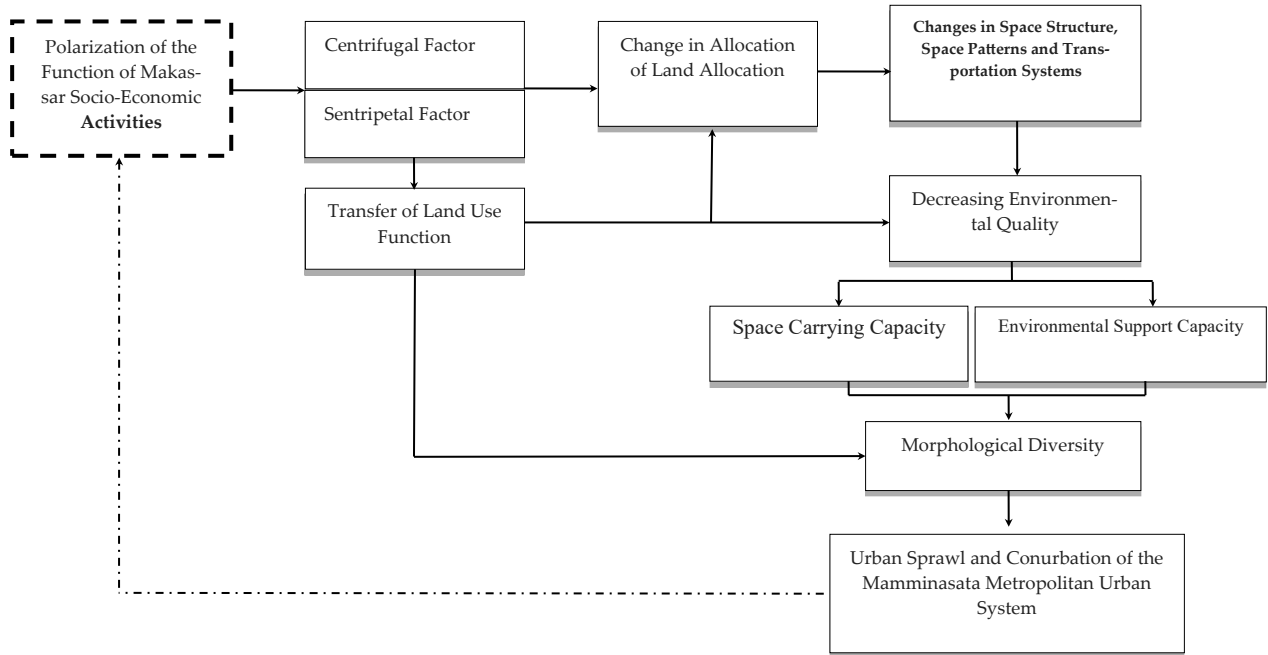

Figure 9. The spatial transformation process of the new city area Metro Tanjung Bunga.

Table 2. Impact of spatial transformation in the new city area of Metro Tanjung Bunga to the Mamminasata Metropolitan urban system

Impact	Parameter	Interpretation
Urban system	Spatial structure	Changes in the structure of urban services are characterized by economic growth poles. Accumulation of urban activity centers towards the suburbs of Mamminasata Metropolitan
	Spatial pattern	Changes in agricultural cultivation activities towards industrial areas on the outskirts of Mamminasata Metropolitan Physical changes to the Mamminasata Metropolitan area due to the allocation of new space functions (houses, works, clans, likes and facilities, and infrastructure).
	Transport movement system	Increased mobility of goods and passenger transportation. Increased volume of motor vehicles and traffic congestion.
Environmental system	Ecosystem condition	Environmental degradation and decreasing Green region coefficient (KDH) in the Mamminasata Metropolitan urban area. Environmental damage due to pollution of soil, water, and air.
	Land-use system	Removal of productive agricultural land-use function. Environmental damage due to pollution of soil, water, and air.
Economic system	Economic activities	Inequality in the mastery of space reproduction and urban dualistic (formal and informant) economic systems. Changes in work relations from traditional economic systems towards urban modern economic systems.
	Land value	Changes in land sale value based on urban space functions. The economic value of the land is oriented to the function of space and the market economy.
Social system	Social structure	Changes in social relations towards differences in modes of production and sharpening of socio-economic strata. Changes in social status based on educational background, expertise, and skills.
	Social mobility	Differences in vertical and horizontal social mobility between immigrants and local residents. Social mobility is characterized by the ability of capital, wealth, and develops towards segregation.
	Social dynamic	Social dynamics are very dynamic characterized by changes in the orientation of agricultural work to urban industry. The social dynamics of immigrants and local residents develop in the direction of urban inter-ethnic segmentation.

development of urban activities surrounding the new city areas; (3) urban sprawl and urban conurbation; (4) integration of activity systems and regional infrastructures. The four factors are positively associated with increasing agility of product and service transportation as well as the mobility of population physically, economically, and socially. Facts from the field indicate long road lines developing lengthwise are the built areas dominated by commercial activity functions. The urban lengthwise lines have controlled the growth of residences and non-residential buildings (Yunus, 2008; Surya, B., 2015^b). Transportation flow is indicated by a sufficiently high volume of motorized vehicles from and to Makassar City, affecting the growth of surrounding urban areas and development of regions physically. This is because one urban system unit often led to single, dispersed, spatial use pattern, urban sprawl, and degradation of the surrounding environment. Generally, urban sprawl is associated with a policy of investment, speculation, rule of land use, and facility pricing (Kustiwan, 2011). Therefore, the development of the new city area MetroTanjung Bunga indicates spatial transformation and change in spatial use recur in the urban area systems of Metropolitan Mamminasata.

Explainable interpretations associated with spatial transformation (see Table 2) are (a) change in urban systems; in this case, improvement of service structure is characterized by accumulation of social-economic activities, tending to develop in urban agglomeration through the creation of market and spatial interaction process in the urban areas of Metropolitan Mamminasata. Agglomeration appears as the outcome of the interaction of increasing returns, trade costs, and factor price differences in the market area due to the meeting of two or more different economic activities (Dahuri and Nugroho, 2012; Tarigan, 2014; Lincaru et al., 2016). Spatial interaction and agglomeration work parallel to connectivity to trading systems, large-scale settlements, tourism, and other urban activities increases the transportation of goods and passengers. Interregional interaction is reflected in transportation facilities and the flow of people, goods, and services (Hurst, 1974; Surya, 2015^b). (b) Degradation of urban environment quality characterized by high pollution burden is associated with various social-economic activities such as beach habitat damage, coastal area ecosystem caused by spatial addition (coast reclamation) in development of the new city area Metro Tanjung Bunga and the problem of water absorption. (c) Developing economic systems have a positive contribution to the land value of urban areas of Metropolitan Mamminasata by increasing economic productivity, trade, service, and tourism. Formal trade results in new buildings in an area that not only have a visual effect but also affects patterns and activities surrounding the structures (Purnamasari, 2013). Besides, economic systems developing in the new city area Metro Tanjung Bunga have tended to follow dualistic models and coexisting formal and informal financial structures, though not existing in hierarchical position. The dynamics lead to inequality in the dominance of urban space, characterized by the domination of capitalism to pre-capitalism production mode, leading to the new social formation (Surya, 2014). (d) Built social systems tend to change in social structure, mobility, and dynamics in the comers and the local community. The developing social relation is the difference between collective adaptation and

interaction aspects. The real impact on the life of local community is repositioning the role and status to plural functions characterized by the urban community. For this reason, the development of the new city area Metro Tanjung Bunga has dualistic characteristics, mixing between planned and traditional residences, and social systems exist as reproduced practices (Setioko, 2009; Giddens, 2010).

It means that social spaces gradually expect changes along with modification in spatial order and mental structures between the comers and the local community. Social space is one of the dominant places and production factor is a fundamental element of social structure decreasing behavior, action, and civilization (Bourdieu, 1997; Kristeva, 2013; Schumpeter, 2013). The results of the study show behavior, action, and civilization between comers and the local community show basic differences based on residence characteristics developing in the new city area Metro Tanjung Bunga. Two main categories are indicating the difference associated with the behavior, action, and civilization; (a) existence of residences developed has a tendency to appear as a well, arranged residence pattern and forms luxury habitation clusters based on economic classes of the comers; (b) residential patterns of the local community early existing in main road lines tend to develop in slums. These two conditions indicate the difference in lifestyle, consumption pattern, and action rationality. In consequence, spatial transformation and change in spatial use lead to social adjustment and its intensity is affected by the dynamics of the development. Furthermore, population mobility towards the new city area of Metro Tanjung Bunga based on the pattern of origin and destination of movement is influenced by two main factors, namely: (1) Population mobility is related to accessibility between regions and between urban areas. This means that the transportation facilities and infrastructure are sufficient to support the mobility of the population from the origin to the destination area. (2) The dominant accumulation of urban activities is developed in the new city area of Metro Tanjung Bunga, namely shopping centers, recreational facilities, education, health services, and other socio-economic activities. The existence of these activities is the driving force for population mobility, circular migration, and opportunities for rural residents to seize employment and business opportunities. Population mobility based on travel destinations in the new city area of Metro Tanjung Bunga is presented in Figure 10.

Figure 10 shows the mobility of the population in the new city area of Metro Tanjung Bunga Makassar City. Interpretations that can be proposed for these results include: First, population mobility for work shows a picture of 58.4% in the supportive category, 20.8% in the sufficiently supportive category, and 20.8% in the not supportive category. Population mobility for economic purposes shows an image of 57.6% in the supportive category, 16% with the sufficiently supportive category, and 26.4% with the not supportive category. Second, population mobility based on inter-regional accessibility shows that there is an image of 54% for the supportive category, 22% for the moderately supportive category, and 24% for the not supportive category. Population mobility based on accessibility between urban areas shows that it is 52.8% for the supportive category, 21.2% for the sufficiently supportive category, and 26% for the not supported category. Third, population mobility based on the mode of public transportation used

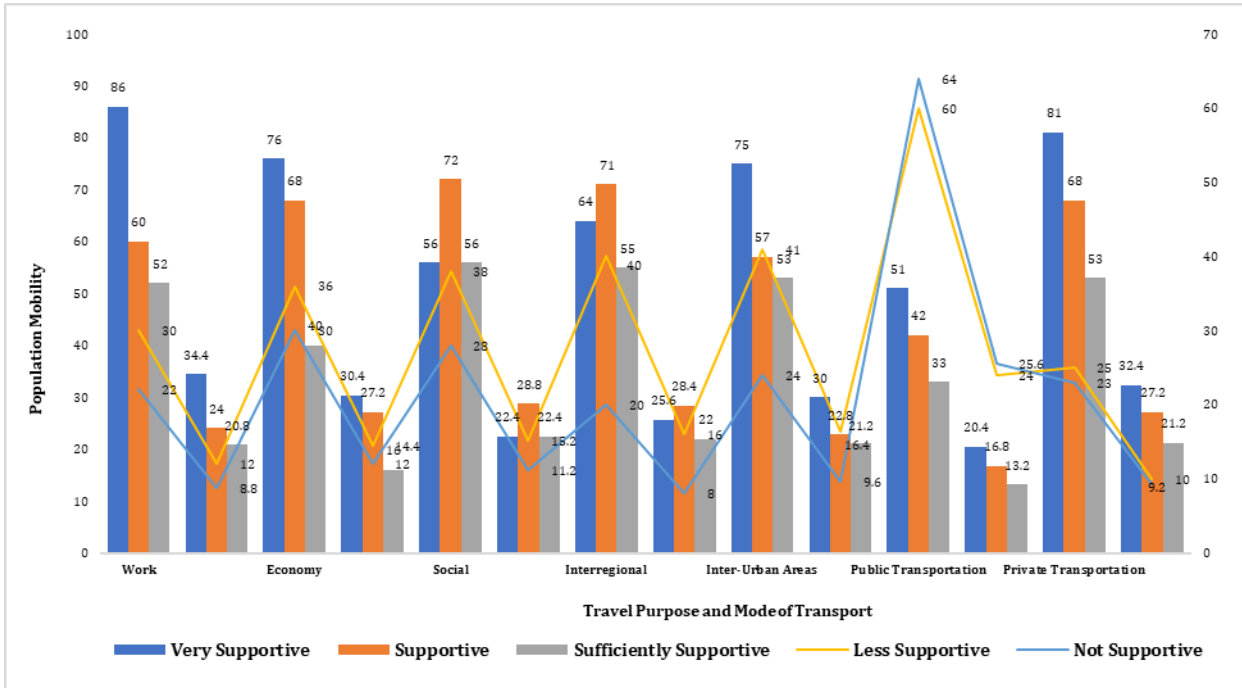

Figure 10. Population mobility based on origin and destination of travel in the new city area Metro Tanjung Bunga. Source: Primary data

shows a picture of 37.2% for the supportive category, 13.2% for the sufficiently supportive category, and 49.6% for the not supported category. Population mobility based on the use of private transportation means an illustration of 59.6% for the supportive category, 21.2% for the sufficiently supportive category, and 19.2% for the not supported category.

These results confirm that population mobility for work, economic, and social purposes is positively associated with an increase in the transportation movement system a fairly, high traffic volume, and traffic jams on the main road section of the Metro Tanjung Bunga. Furthermore, the inter-regional and inter-urban accessibility confirms that the mobility of the population towards the area Metro Tanjung Bunga is positively associated with the integration and interaction of the Metropolitan Mamminasata urban spatial to be quite high. Then the use of private transportation facilities which is quite dominant confirms that the pattern of population movement towards the new city area of Metro Tanjung Bunga is not yet supported by adequate public transportation facilities. Thus, it can be concluded that population mobility coupled with urban spatial integration and limited public transportation facilities from and to the new city area of Metro Tanjung Bunga contribute positively to the increase in traffic volume and the dominant choice of private transportation is used by the population due to limited public transportation, which has an impact on increasing air pollution and environmental degradation. Dependence on transportation and the use of dominant private means of transportation will have an impact on traffic congestion and air pollution, which leads to a decrease in the quality of the urban environment (Štraub, D, 2020; Surya, B, et al., 2020). Furthermore, the transportation movement system based on activity patterns, road network systems, and movement systems is presented in Figure 11.

Figure 11 shows the transportation system and activity patterns in the new city area of Metro Tanjung Bunga Makassar City. The interpretations that can be proposed for these results include: First, the economic activity that is

developing in the Metro Tanjung Bunga area gives a picture of 60.8% in the supportive category, 22.4% in the sufficiently supportive category, and 16.8% in the not supportive category. The social activity that develops shows a picture of 48.8% with the supportive category, 27.2% with the sufficiently supportive category, and 24% with the not supportive category. Second, the condition of the road network in the new city area of Metro Tanjung Bunga shows 56.8% in the supportive category, 20.8% in the sufficiently supportive category, and 22.4% in the not supported category. Third, the capacity of the road body gives an illustration of 24% in the supportive category, 16.8% with the sufficiently supportive category, and 59.2% with the not supportive category. The availability of transportation facilities gives an illustration of 26.4% with the supportive category, 17.2% with the sufficiently supportive category, and 56.4% with the not supporting category. These results confirm that the pattern of socio-economic activity that develops in the new city area of Metro Tanjung Bunga has an impact on improving the transportation movement system and affects the condition of the transportation system in relation to the capacity of the road body and the availability of transportation facilities. Thus, it can be concluded that socio-economic activities that tend to increase have a positive contribution to the transportation movement system and its influence on the condition of the road network system and the availability of transportation facilities to and from the new city area of Metro Tanjung Bunga. The distribution of urban activities where the central region appears due to economic, political, educational, or cultural factors causes high spatial accumulation that affects the transportation system movement and land-use changes in the direction of environmental degradation (Rodrigue, J.P, 2020; Surya, B, et al., 2020). Furthermore, the environmental quality degradation of the new city area of Metro Tanjung Bunga Makassar City is presented in Figure 12.

Figure 12A shows the potential and sources of pollution caused by social activities in the new city area of Metro

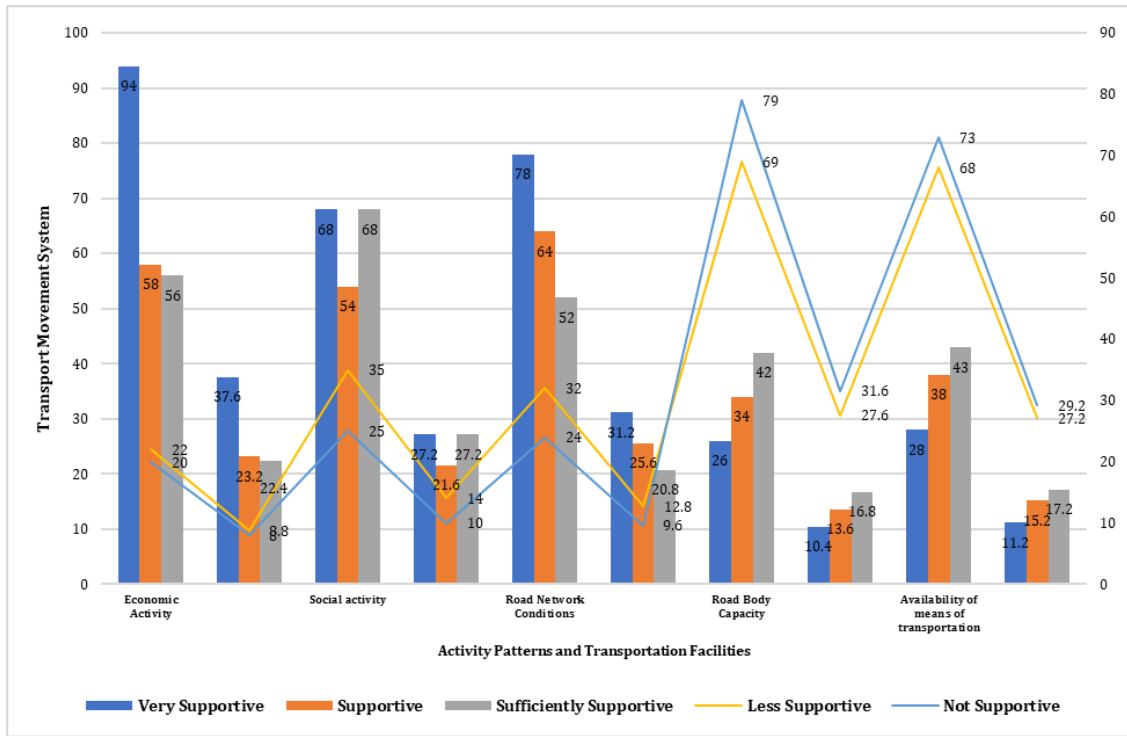

Figure 11. The transportation system and activity patterns of the new city area Metro Tanjung Bunga. Source: Primary data

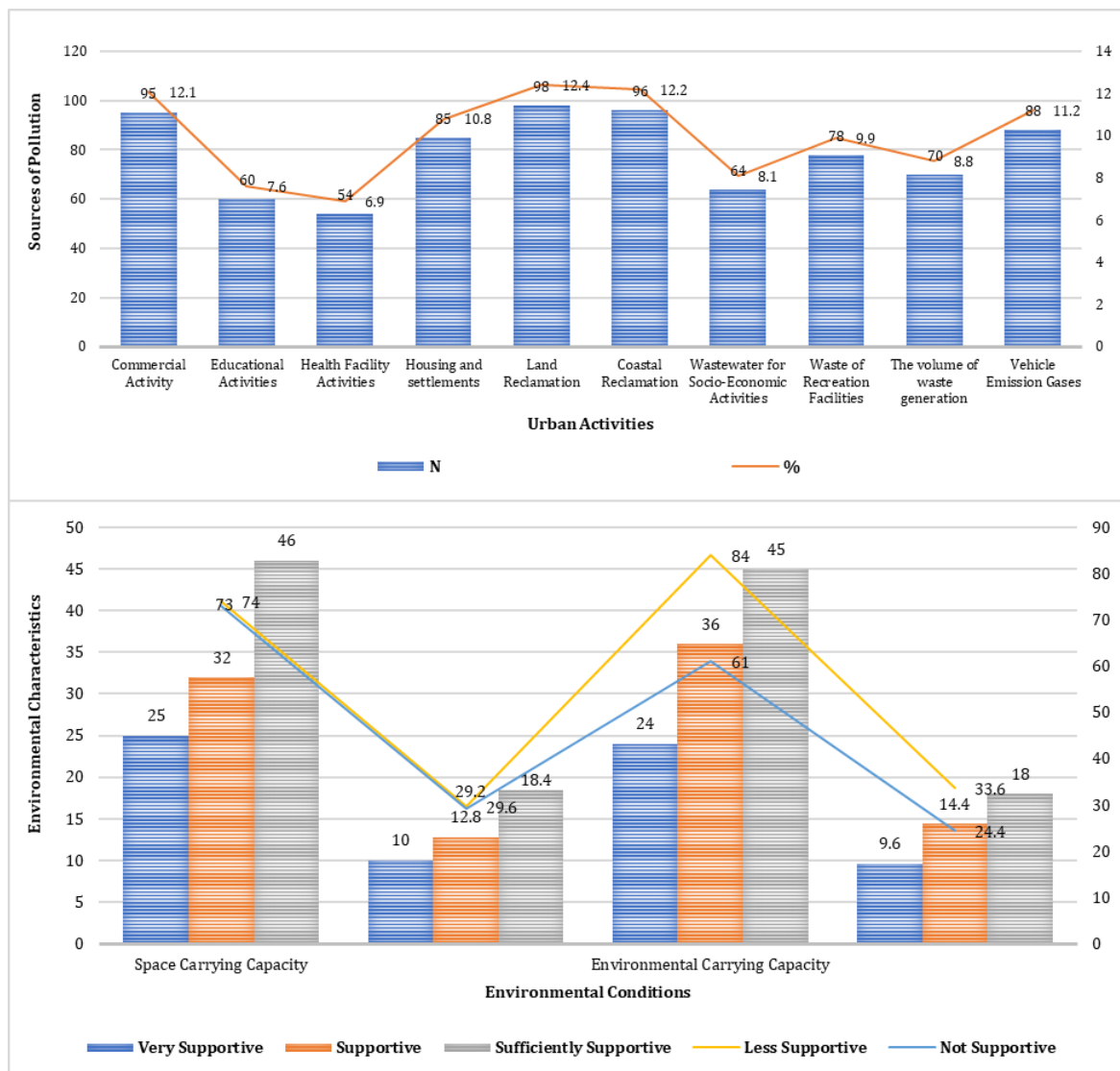

Figure 12. Decreasing environmental quality of the new area Metro Tanjung Bunga. (A) The source of pollution, (B) The carrying capacity of the environment. Source: Primary data

Tanjung Bunga Makassar City. Interpretations that can be proposed for these results include (1) potential sources of pollution that predominantly affect environmental quality degradation, namely land reclamation of 12.4% for housing and settlement development needs, reclamation of coastal areas of 12.2%, and commercial activities of 12.1%; (2) Air pollution produced by vehicle exhaust gas of 11.2%, and (3) Pollution generated by educational activities of 7.6% and health activities of 6.9%. Thus, an increase in socio-economic activity coupled with an increase in the volume of vehicles on the main road corridor of the Tanjung Bunga Metro is positively associated with a decrease in environmental quality. This condition is characterized by damage to mangrove forest habitat in coastal areas, loss of natural vegetation, increase in dust particles in the air due to reclamation, a decrease in river water quality due to waste from socio-economic activities, and household waste. Increased development activities to meet the needs of commercial development, large-scale settlements, industry, services, and tourism have an impact on the conversion of productive agricultural land and changes in land use towards environmental degradation (Grossauer, F and Stoeglehne, G, 2020; Surya, B, et al., 2020).

Figure 12B shows the carrying capacity of the environment in the new city area Metro Tanjung Bunga of Makassar City. Interpretations that can be put forward for these results include: (1) changes in environmental characteristics concerning space capacity obtained an overview of 22.8% in the supportive category, 18.4% in the sufficiently supportive category, and 58.8% in the not supportive category. Environmental characteristics related to the carrying capacity of the environment obtained an overview of 24% with the supportive category, 18.0% with the sufficiently supportive category, and 58% with the not supportive category. These results confirm that the development of socio-economic activities, transportation infrastructure, and large-scale settlements, is positively associated with an increase in a built-up area, building density, and population density and contributes positively to the capacity of the space capacity and a decrease in the environmental quality of the new city area of Metro Tanjung Bunga of Makassar City. Thus, a policy tool for urban development, integration of transportation systems, and land

use is needed through cross-regional policy interventions to optimize the use of natural resources and save the environment in areas to be developed as new urban areas by adopting the concept of sustainable development (OECD, 2019; Surya B, et al., 2020). Furthermore, the effect of changes in land use, activity systems, population mobility, and transportation systems on the environmental quality degradation of the new city area Metro Tanjung Bunga is presented in Table 3.

The results of Table 3 illustrate that changes in land use, activity systems, population mobility, and transportation systems are positively correlated with a decrease in the environmental quality of the new city area Metro Tanjung Bunga of Makassar City with a coefficient of determination of 60.8%. Thus, development policies that are oriented towards changes in land use, population mobility, and transportation movement systems contribute positively to the conversion of productive agricultural land, traffic congestion, building density, and population density towards a decrease in the quality of the environment in suburban areas (Shen, L, et al., 2018; Llorca, C, et al, 2020; Surya, B, et al., 2020).

Sustainability of Development in the New City Area of Metro Tanjung Bunga

The sustainable development in the new city area Metro Tanjung Bunga will be improved in the following main dimensions; (a) environmental sustainability-oriented to safety. Sustainability of environment refers to controlling of spatial use and optimization of land use, water and ecosystem service resources, and minimization of environmental pollution. The local improvement of ecosystem services is facilitated by constructing green infrastructure, or the rigid spatial restraint created by urban growth boundaries (Jian Peng, et.al, 2018). The efforts are made by preparing and developing green infrastructure based on natural disaster mitigation and conservation considering is located, in the coastal area. (b) Economic sustainability is oriented to the development of local economic potential through economic empowerment of local communities still existing in the new city area Metro Tanjung Bunga. The idea is implemented by the economic balance principle between the comers and the local

Table 3. Summary of the results of the regression coefficient significance test.

	m	Coefficient	Error	t-count	t-table
Land use change to reduce environmental quality degradation (ryx ₁)		0.273	0.063	2.863	1.93
Urban activity system to environmental quality degradation (ryx ₂)		0.264	0.056	2.628	1.93
Mobility of the population to environmental quality degradation (ryx ₃)		0.204	0.082	4.253	1.93
Transportation system to environmental quality degradation (ryx ₄)		0.136	0.063	2.845	1.93
Source variant	Sum of squares (JK)	Free Degrees (db)	Average of the sum of the squares (RJK)	F-count	F- table α = 0.05
Regression	24,870	4	8,260	85,816	5,45
Residue	0,470	8	0,046		
Total	24,87	12	-	-	-
R	R ²	db1	db2	F-count	F-table
0,780	0,608	4	8	85,816	5,45

community. (c) Social sustainability is oriented to social capital reinforcement through development capital, which can be human, produced economic, or natural in order, to avoid social conflict. The principle is implemented by developing economic assets of marginal community in terms of access to land resources, business capital, improving mutual reliance, collaborating, reinforcing collective identity, equality and constructing a shared future. The three factors should be implemented consistently in the development and construction. The urbanization course improves the quality and reduce the resources and environmental costs of urbanization along with the environment, energy resources. However, this infrastructure requires holistic comprehension and actionable approaches to the city as the nexus of environmental context, built set-up, and human communities (Xingliang Guan, at al., 2018; Nan Li, at al., 2018). The sustainability of the development of the new city area of Metro Tanjung Bunga is presented in Figure 13.

The four explainable issues (see Figure 13) are (1) Management of environment-oriented to green city development based on the development of renewable energy resources, wise management of natural resources, and management of ecosystem service based on information technology. (2) Economic systems are developed to create job opportunities, coaching of people’s productive economic business, and the development of human resources as well as the incorporation of economic assets and land to the local community. (3) Social systems are directed to two following main issues; (a) development of human resources potential consisting of education and development of the social-cultural character of the community, (b) giving easy access to education, healthcare, and safety insurance services to residents of the local community in the new urban area. (4) Improvement of functions and roles of government through the strengthening of institutional capacity, strengthening of planning systems, and role of people in development. Governments are likely to have key, roles as promoters or in legitimation (or both), but other actors are also likely to contribute significantly, especially social movements and civil society groups (James, J. Patterson, et al., 2017). The four pillars of development in the new urban area include inclusive principle, effectiveness, economic efficiency, and the creation of sustainable social cohesion.

Conclusions

The spatial transformation followed by changes in land use causes changes in the structure and spatial patterns of the suburbs towards the development of new urban areas. Furthermore, the intensity of changes in land use, urban activity systems, population mobility, and transportation systems for new urban areas are positively correlated with decreasing environmental quality, morphological diversity, decreasing productivity of agricultural land, and increasing environmental pollution. The dynamics of the development of new urban areas also have an impact on physical, economic, and social segregation towards a dualistic economic system, namely formal and informal urban activities, planned residential areas, and slum settlements. Thus, the development of the city towards the suburbs through the development of the new city area of the Metro Tanjung Bunga and the polarization of the socio-economic functions of the core city, coupled with land-use changes, has a positive contribution to system integration and urban spatial interaction of Metropolitan Mamminasata towards economic growth and hierarchical formation service centers and their influence on spatial dynamics and environmental degradation.

The spatial transformation accompanied by changes in land use tends to changes in social structure, population mobility, and socio-economic dynamics between land residents and local communities. The very intensive suburbanization towards the new urban area of Metro Tanjung Bunga contributed positively to the gentrification process in line with the increase in capital flows and investment in the development of new urban areas which contributed positively to socio-economic inequalities between expansive newcomers and local communities. Thus, the sustainability of the development of new urban areas in the future is very important to consider economic, social, and environmental sustainability-oriented to the principles of inclusion, effectiveness, and efficiency of spatial use, equality in economic access, and creation of social cohesion.

Because this study was conducted in a limited scope, further research is needed to support the results of this study.

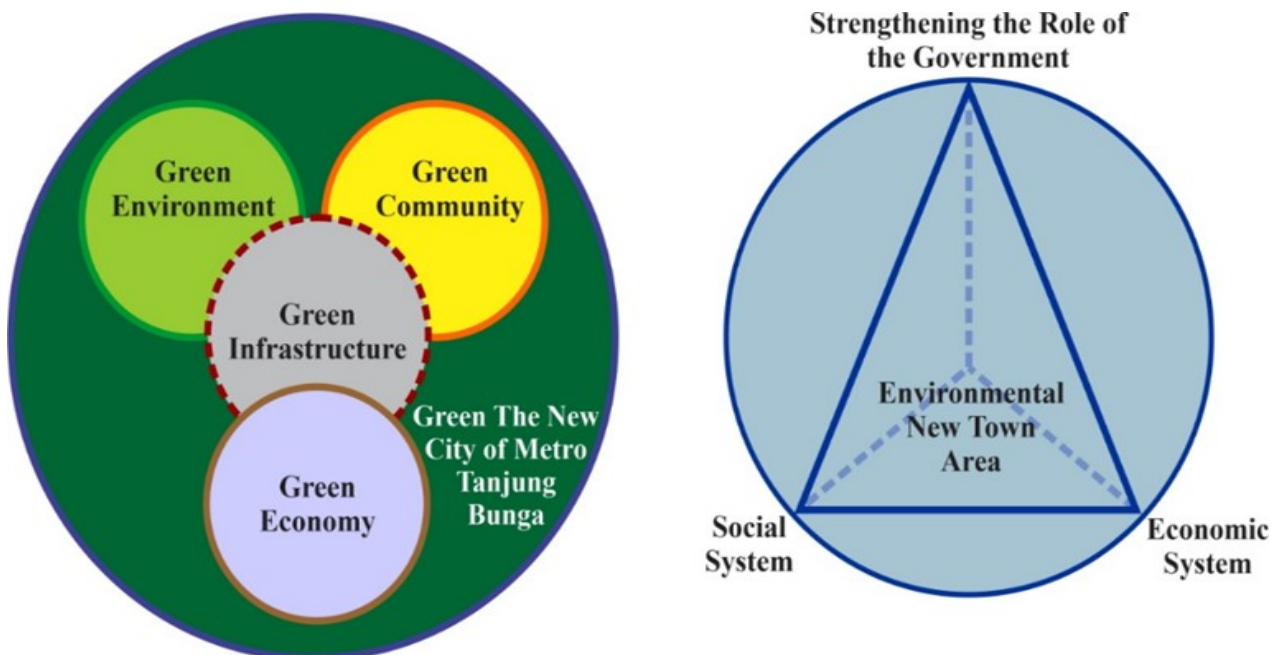

Figure 13. Sustainability of development in the new city area of Metro Tanjung Bunga, Makassar City.

Thus, further studies are recommended, namely: (1) Model for developing new urban areas and urban spatial integration for Metropolitan Mamminasata, and (2) Model for economic, social, and environmental sustainability of new urban areas based on community participation.

Acknowledgments

We are grateful for the participation of stakeholders in contributing ideas during the implementation of this study. Thank you to LPPM Bosowa University for the support and financial assistance in carrying out this study.

References

- Andong, R.F, and Sajor, E., (2017). Urban Sprawl, Public Transport, and Increasing CO₂ Emission: the case of Metro Manila, Philippines. *Journal Environment, Development and Sustainability*, 19,99-123.
- Armstrong, W.R. dan Terry McGee., (2002). "A Theory of Urban Involution." page 220-234 in Hans-Dieter Ever (ed.), *Sociology of South-Eats Asia: Reading on Social Change and Development*. Kuala Lumpur: Oxford University Press.
- Almeida, T., (2013). Neoliberal Policy and the Growth of Slums. *Publisher Prospect Journal of International Affairs at UCSD*. <https://prospectjournal.org/2012/05/21/neoliberal-policy-and-the-growth-of-slums/>
- Basant, Maheshwari, et al., (eds.), (2016). Balanced Urban Development: Is It a Myth or Reality? *Springer Open*. https://link.springer.com/chapter/10.1007/978-3-319-28112-4_1
- Briant, C.R. et al., (1982). The City's Countrysides: Land and its Management in Rural Urban Fringe. *Longman Inc*. New York.
- Bourdieu, P. (Coord.), (1997). A Miséria do Mundo. Petrópolis: Editora Vozes. <http://www.netmundi.org/home/wp-content/uploads/2018/01/BOURDIEU-Pierre-org.-A-mis%C3%A9ria-do-mundo.pdf>
- Berger, Peter L., (1984). *Revolusi Kapitalis*. Jakarta. Penerbit LP3ES.
- _____. Bappeda Kota Makassar (2017). Rencana Tata Ruang Kota Makassar 2015-2035.
- Cocheci R.M. et al., (2015). Environmental Degradation in Rural areas with High Anthropic Pressure-Impact and Planning Models. *Carpathian Journal of Earth and Environmental Sciences*,10,3,25-36.
- Chang, S. et al., (2013). Discussion on sustainable land use allocation toward the sustainable city A practice on Linco New Town. *Procedia Environmental Sciences*, 17,408-417.
- Creswell, J.W., (2016). *Research Design. Pendekatan Metode Kualitatif, Kuantitatif, dan Campuran*. Edisi 4. Penerbit. Pustaka Pelajar.
- Cochran, W.G., (1991). *Teknik Penarikan Sampel*. Edisi Ketiga. Penerbit Universitas Indonesia, Depok.
- Denzin and Lincoln., (2009). *Handbook of Qualitative Research*. Penerbit. Pustaka Pelajar.
- Dahuri, R. dan Nugroho, I., (2012). *Pembangunan Wilayah: Perspektif Ekonomi, Sosial dan Lingkungan*. Penerbit. LP3ES.
- Firman T., (2004). New town development in Jakarta Metropolitan Region: a perspective of spatial segregation. *Pergamon. Habitat International*, 28,349-368.
- Friedman, J, and Alonso, W., (1975). *Regional Policy*. Reading in Theory and Application. Massachusetts. MIT Press.
- Friedman, J., (1988). Editorial; Life Space and Economic Space, Essay in Third Word Planning.
- Gradinaru S.R. et al., (2015). Do Post-Socialist Urban Areas Maintain their Sustainable Compact Form? Romanian Urban Areas as Case Study. *Journal of Urban and Regional Analysis*, VII, 2, 2015a,129-144.
- Giddens, A., (2010). *Teori Strukturasi: Dasar-Dasar Pembentukan Manusia* (terjemahan oleh: Maufur dan Daryatno, Judul Asli: *The Constitution of Society: Online of the Theory of Structuration*. University of California Press, USA, 1984.
- Giyarsih, S.R., (2001). Gejala Urban Sprawl Sebagai Pemicu Proses Densifikasi Permukiman di Daerah Pinggiran Kota (Urban Fringe Area). *Jurnal Perencanaan Wilayah dan Kota*, 12,1-4.
- Grossauer, F and Stoegelehne, G., (2020). Bioeconomy—Spatial Requirements for Sustainable Development. *Sustainability*, 12,1877, 1-28.
- Hakim, I. and Parolin, B., (2008). Spatial Structure and Spatial Impacts of the Jakarta Metropolitan area: a Southeast Asian EMR Perspective. *International Journal of Civil, Environmental, Structural, Construction and Architectural Engineering*, 2,10,227-235.
- Harvey, D., (2009). *Neoliberalisme Dan Restorasi Kelas Kapitalis*. Penerbit. Resist Book.
- Hariyono, P., (2010). *Perencanaan Pembangunan Kota Dan Perubahan Paradigma*. Penerbit. Pustaka Pelajar.
- Hanief, F., (2014). Pengaruh Urban Sprawl Terhadap Perubahan Bentuk Kota Semarang Ditinjau Dari Perubahan Kondisi Fisik Kelurahan Meteseh Kecamatan Tembalang. *Jurnal Ruang*, 2,1, 341-350.
- Hochstenbach, C and Musterd, S., (2018). Gentrification and the suburbanization of poverty: changing urban geographies through boom and bust periods. *Urban Geography*, 39,1, 26-53.
- Hurst, E., (1974). *Transportation Geography: Comments and Readings*. New York, United States. McGraw-Hill, Inc.
- Haber, W., (2008). Biological diversity—A concept going astray? *Gaia-Ecological. Perspectives for Science and Society*, 17(1), 91-96.
- James, J. Patterson, et al., (2017). Political feasibility of 1.5°C societal transformations: the role of social justice. *Environmental Sustainability*, 31, 1-9.
- Janssens, X., Bruneau, E., & Lebrun, P., (2006). Prediction of the potential honey production at the apiary scale using a Geographical Information System (GIS). *Apidologie*, 37(3), 351-365.
- Jian Peng, et al., (2018). Linking ecological degradation risk to identify ecological security patterns in a rapidly urbanizing landscape. *Habitat International*, 71, 110-124.
- Inoguchi, Takashi et al., (2015). Kota Dan Lingkungan. Pendekatan Baru Masyarakat Berwawasan Ekologi. Penerbit. LP3ES.
- Kristeva, N.S., (2013). *Kapitalisme Negara Dan Masyarakat*. Penerbit. Pustaka Pelajar.
- Kustiwan, I., (2011). *Pengendalian Perkembangan Fisik Kota: Penanganan Urban Sprawl*. Dalam Bunga Rampai Pembangunan Kota Indonesia Dalam Abad 21. Konsep Dan Pendekatan Pembangunan di Indonesia. Hlm 421-437: Edisi 2. Penerbit URDI.
- Kustiwan, I dan Pontoh, N.K., (2010). *Pengantar Perencanaan Perkotaan*. Penerbit. ITB.
- Kolip, U. dan Setiadi Elly, M., (2011). *Pengantar Sosiologi Pemahaman Fakta Dan Gejala Permasalahan Sosial: Teori, Aplikasi, Dan Pemecahannya*. Penerbit. Kencana Prenadamedia Group.
- Lee, L., (1979). Factors Affecting Land Use Change in the Rural-Urban Fringe. *Grow and Change: A Journal of Regional Development*, 10, 25-31.
- Lincaru. et al., (2016). Peri-urban Areas and Land Use Structure in Romania at LAU2 Level: An Exploratory Spatial Data Analysis. *Procedia Environmental Sciences* 32,124-137.
- Llorca, C, et al., (2020). Integration of Land Use and Transport to Reach Sustainable Development Goals: Will Radical Scenarios Actually Get Us There? *Sustainability*, 12, 9795,1-19.
- Martono, N., (2014). *Sosiologi Perubahan Sosial: Perspektif Klasik, Modern, Posmodern, dan Poskolonial*. Penerbit. RajaGrafindo Persada.
- McGee, T.G., (1997). The Emergence of Desa-Kota Region in Asia: Expanding a Hypothesis, in Notton Ginsburg, Bruce Koppel, T.G. McGee (eds). *The Extended Metropolis and Settlement Transition in Asia*. Honolulu: The University of Hawai Press.

- Maslow, A.H., (1994). Motivasi dan Kepribadian (Teori Motivasi dengan Pendekatan hierarki Kebutuhan Manusia). Penerbit. PT PBP, Jakarta.
- M.J. Weaving, et al., (2014). Sex-biased space-use response to urbanization in an endemic urban adapter. *Landscape and Urban Planning*, 130, 73–80.
- Nan Li, et al., (2018). Urban sustainability education: Challenges and pedagogical experiments. *Habitat International*, 71,70-80.
- OECD., (2019). SPINE Spatial Planning Instruments and the Environment. Available online: <https://www.oecd.org/environment/tools-evaluation/brochure-spatial-planning-instruments-and-the-environment.pdf> (accessed on 20 April 2020)
- Parasati, H. (2011). Kebijakan Pembangunan Perkotaan Dalam Kurun Waktu RPJPN 2005-2025. Dalam Bunga Rampai Pembangunan Kota Indonesia, Dalam Abad 21. Konsep Dan Pendekatan Pembangunan di Indonesia. Hlm 3-20: Edisi 2. Penerbit URDI.
- Prados, M. J., (2009). *Naturbanization: New Identities and Processes for Rural-Natural Areas*. London: Taylor and Francis Group.
- Purnamasari, D. W., (2013). Model Konseptual Adaptasi Ruang Kampung Kota Sebagai Akibat Keberadaan Sektor Perdagangan Formal (Kampung Sekayu Kota Semarang). *TATA LOKA*. 15,2, 140-159.
- Rodrigue, J.P., (2020). *Urban Land Use and Transportation: The Geography of Transport Systems*, 5th ed.; Routledge: New York, NY, USA, 456p, Available online: https://transportgeography.org/?page_id=4613 (accessed on 12 April 2020) ISBN: 978-0-367-36463-2
- Sui Z, et. al., (2001). Modeling the dynamics of landscape structure in Asia's emerging desa kota regions: a case study in Shenzhen. *Landscape and Urban Planning*, 53,37-52.
- Surya, B., (2010). *Urbanisasi dan Pertumbuhan Kota*. Penerbit. Fahmis Pustaka
- Surya, B., (2014^a). *Penetrasi Kapitalisme Memarginalkan Komunitas Lokal*. Penerbit Fahmis Pustaka.
- Surya, B., (2014^b). Social Change, Spatial Articulation in the Dynamics of Boomtown Construction and Development (Case Study of Metro Tanjung Bunga Boomtown, Makassar). *Modern Applied Science*, 8,4, 238-245.
- Surya, B. (2015^a). *Sosiologi Spasial Perkotaan. Gagasan dan Pengalaman Empiris*. Penerbit Fahmis Pustaka.
- Surya, B., (2015^b). The Dynamics of Spatial Structure and Spatial Pattern Changes at the Fringe Area of Makassar City. *Indonesian Journal of Geography*, 47, 1,11-19.
- Surya, B., (2015^c). Spatial Articulation and Co-Existence of Mode of Production in the Dynamics of Development at the Urban Fringe of Makassar City. *Journal of Engineering and Applied Science*, 10,8,214-222.
- Surya, B., (2015^d). Spatial Interaction Pattern and the Process of City Activity Formation System (Case study, Ternate City, Tidore Archipelago City and Sofifi City of North Maluku, Indonesia). *Research Journal of Applied Sciences*, 10,12, 880-892.
- Surya, B., (2016). Change Phenomena of Spatial Physical in the Dynamics of Development in Urban Fringe Area. *Indonesian Journal of Geography*,48,2, 118-134.
- Sugiyono., (2016). *Metode Penelitian dan Pengembangan. Untuk Bidang: Pendidikan, Manajemen, Sosial dan Teknik*. Penerbit. Alfabeta. Bandung.
- Surya, B, et al., (2018^a). Economic Gentrification and Sociocultural Transformation Metropolitan Suburban of Mamminasata. *Journal of Engineering and Applied Science*, 13,15,6072-6084.
- Surya, B., (2018). Transformasi Spasial Dan Kota Berkelanjutan (Perspektif Sosiokultural, Ekonomi, dan Fisik Lingkungan). Penerbit. PT. RajaGrafindo Persada. Jakarta.
- Surya, B., et al., (2018^b). Transformation of metropolitan suburban area (a study on new town development in Moncongloe-Pattalassang Metropolitan Maminasata). *IOP Conf. Series: Earth and Environmental Science*,202 012027, 1-10.
- Surya, B, et al., (2018^c). Inequality of Space Reproduction Control and Urban Slum Area Management Sustainability (Case Study: Slum Area of Buloa Urban Village in Makassar City). *Journal of Engineering and Applied Science*, 13,15,6033-6042.
- Soussan, John., (1981). *The Urban Fringe in The Third World*. Working Paper 316. School of the Geography University of Leeds. London.
- Štraub, D., (2020). The Effects of Fare-Free Public Transport: A Lesson from Frýdek-Místek (Czechia). *Sustainability*, 12(21), 9111,1-15.
- Surya, B, et al., (2020). The Complexity of Space Utilization and Environmental Pollution Control in the Main Corridor of Makassar City, South Sulawesi, Indonesia. *Sustainability*, 12 (21), 9244,1-41.
- Sassen, Saskia., (1991). *The global city: New York, London, Tokyo*. Princeton: Princeton University Press.
- Sugiana, K., (2011). Pengembangan Wilayah Melalui Keterkaitan Desa-Kota: Dalam Bunga Rampai Pembangunan Kota Indonesia Dalam Abad 21. Konsep Dan Pendekatan Pembangunan di Indonesia. 147-167: Edisi 2. Penerbit URDI.
- Surya, B, et al., (2020). Land Use Change, Spatial Interaction, and Sustainable Development in the Metropolitan Urban Areas, South Sulawesi Province, Indonesia. *Land*, 9(3),95,1-43.
- Surya, B, et al., (2020). Environmental Pollution Control and Sustainability Management of Slum Settlements in Makassar City, South Sulawesi, Indonesia. *Land*, 9, 279, 1-34.
- Setioko, et al., (2012). Towards sustainable urban growth: The unaffected fisherman settlement setting (with case study Semarang coastal area). *Procedia Environmental Sciences* 17,401– 407.
- Srinivas, H., (2012). Defining Squatter Settlement. <http://www.gdrc.org/uem/definesquatter>. Diakses tanggal 30 Agustus, 2017.
- Surya, B, et al., (2020). Natural Resource Conservation Based on Community Economic Empowerment: Perspectives on Watershed Management and Slum Settlements in Makassar City, South Sulawesi, Indonesia. *Land*,9,104,1-31.
- Shen, L., et al., (2018). Sustainable Strategies for Transportation Development in Emerging Cities in China: A Simulation Approach. *Sustainability*, 10,844, 1-22.
- Schumpeter, Joseph, A., (2013). *Capitalism, Socialism Dan Democracy*. Penerbit. Pustaka Pelajar.
- Schreiber, S. J., & Kelton, M., (2005). Sink habitats can alter ecological outcomes for competing species. *Journal of Animal Ecology*, 74(6), 995-1004.
- Salusu., (2015). *Pengambilan Keputusan Strategik: Untuk Organisasi Publik Dan Organisasi Nonprofit*. Penerbit. PT. Gramedia, Jakarta.
- Saefullah, Asep Djaja., 1993. *Pendekatan Kualitatif dan Kuantitatif Lapangan: Khususnya Dalam Studi Kependudukan*. Penerbit Media Bandung.
- Surya, B, et al., (2020). Management of Slum-Based Urban Farming and Economic Empowerment of the Community of Makassar City, South Sulawesi, Indonesia. *Sustainability*,12,7324, 1-42.
- Taylor, P. D., Fahrig, L., Henein, K., & Merriam, G., (1993). Connectivity is a vital element of landscape structure. *Oikos*, 68 (3), 571–573.
- Tarigan, R., (2014). *Ekonomi Regional: Teori dan Aplikasi*. Penerbit. PT. Bumi Aksara.
- Utami, S.D., (2015). Foreign Direct Investment and Regional Development in Jakarta Metropolitan Area. Sustainable Megacities: vulnerability, diversity, and livability. The 5th International Conference of Jabodetabek Studi Forum. IPB International Convention Center. 495-505.
- V.P. Singh, et al., (2016). Options and Strategies for Balanced Development for Liveable Cities: An Epilogue. Springer Open. https://doi.org/10.1007/978-3-319-28112-4_35
- Vizzari, et al., (2015). Landscape sequences along the urban-rural-natural gradient: A novel geospatial approach for identification and analysis. *Landscape and Urban Planning*, 140, 42–55.

- Qu Yanbo et al., (2018). Multi-scale analysis on spatial morphology differentiation and formation mechanism of rural residential land: A case study in Shandong Province, China. *Habitat International*, 71,135-146.
- Winarso, H. et al., (2015). Peri-urban transformation in the Jakarta metropolitan area. *Habitat International*, 49,221-229.
- Wei, C., Taubenbock, H., & Blaschke, T., (2017). Measuring urban agglomeration using a city-scale dasymetric population map: A study in the pearl river delta, China. *Habitat International*, 59, 32-43.
- Winarso, H., et al., (2015). Peri-urban transformation in the Jakarta metropolitan area. *Habitat International*, 49,221-229.
- Xingliang Guan, et al., (2018). Assessment on the urbanization strategy in China: Achievements, challenges, and reflections. *Habitat International*,71,97-109.
- Yunus, S.H., 2005. Manajemen Kota Prespektif Spasial. Penerbit. Pustaka Pelajar.
- Yunus, S.H., 2006. Megapolitan: Konsep, Problematika dan Prospek. Penerbit Pustaka Pelajar.
- Yunus, S.H., 2008. Dinamika Wilayah Peri-Urban Diterminan Masa Depan Kota. Penerbit. Pustaka Pelajar.
- Zhao., (2016). An 'unceasing war' on land development on the urban fringe of Beijing: A case study of gated informal housing communities. *Cities*, 60,139-146.